

Sensors and Systems

Product Overview
for Factory Automation

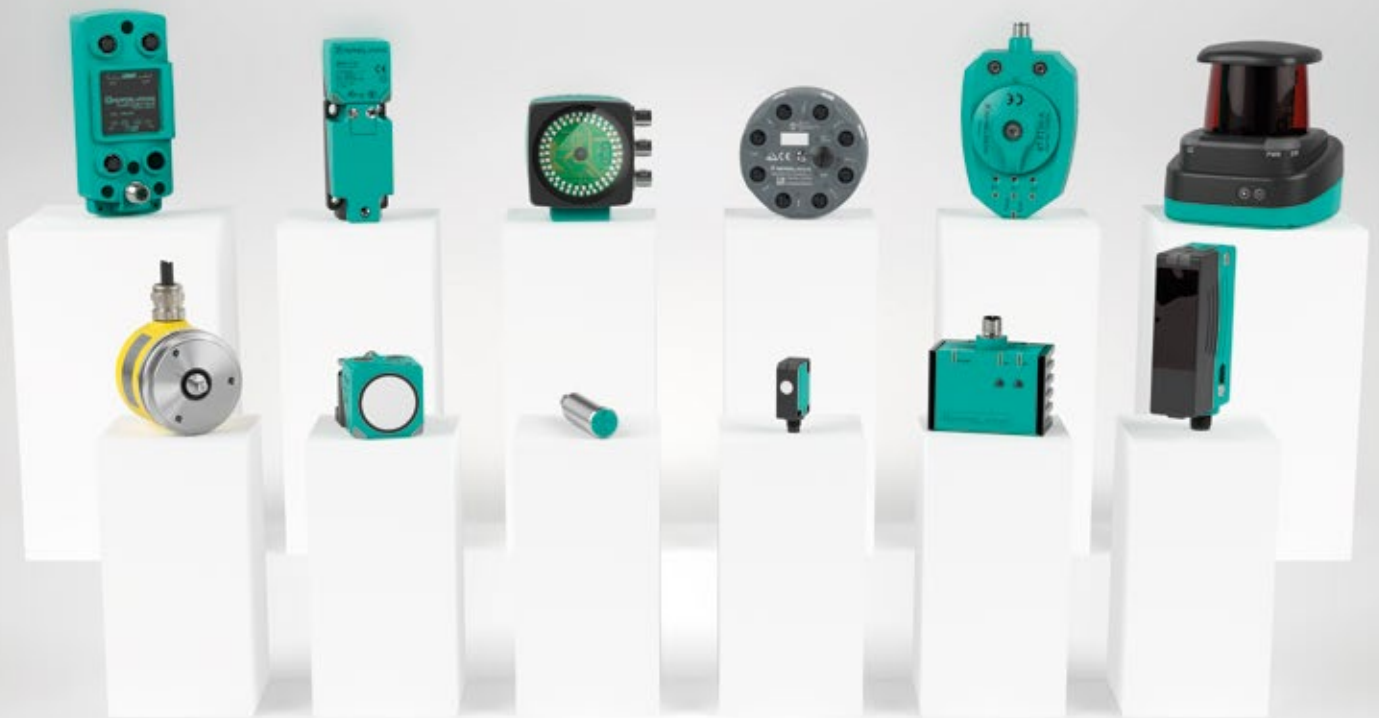

Your automation, our passion.

pf PEPPERL+FUCHS

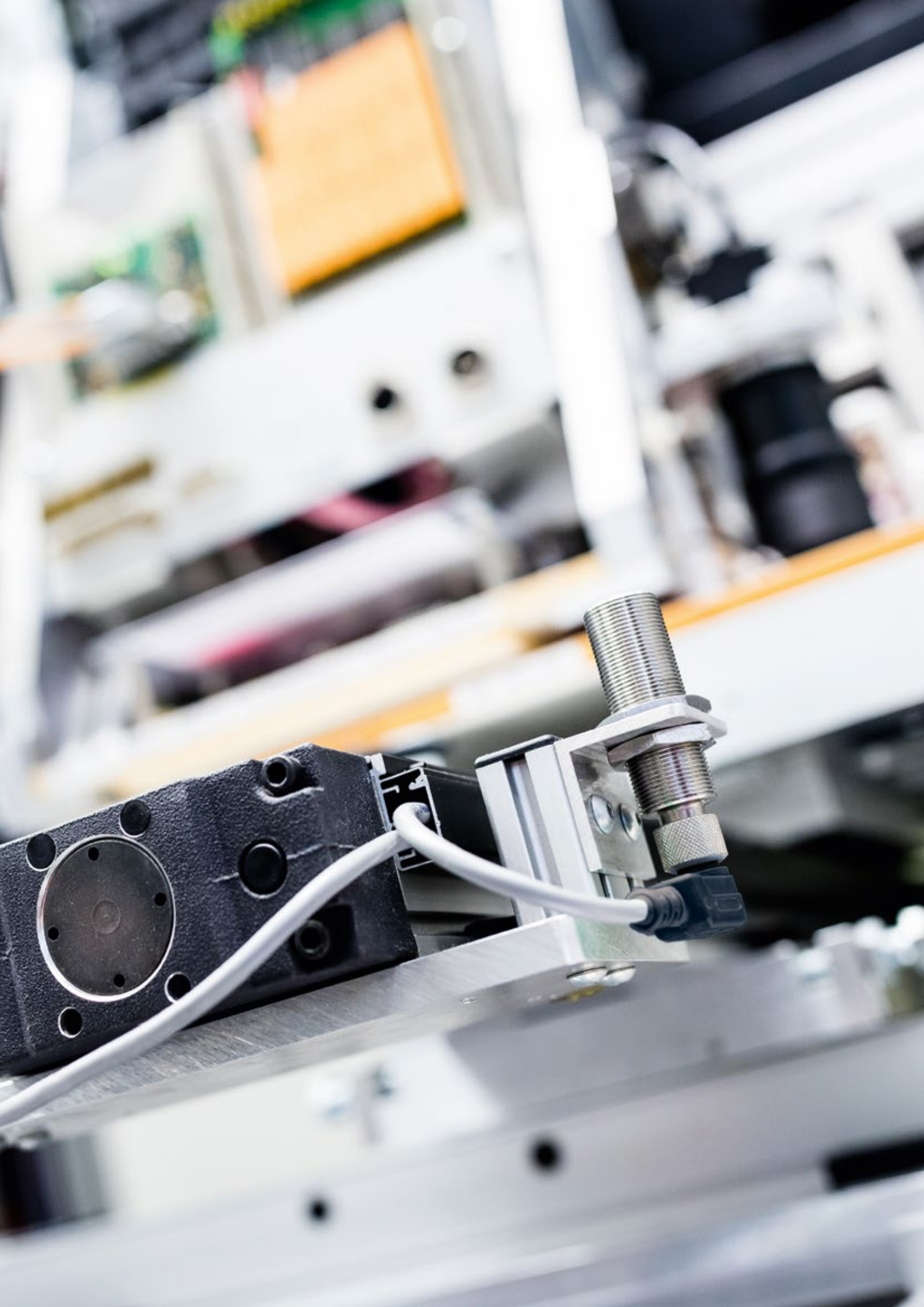

Table of Contents

Sensorik4.0®	4
Proximity Sensors	12
Photoelectric Sensors	22
Ultrasonic Sensors	34
Identification Systems	44
Industrial Vision	60
Positioning Systems	66
Inclination and Acceleration Sensors	74
Rotary Encoders	80
Industrial Communication	88
Connectivity	100



Innovative Solutions. Perfect Applications.

As a technology leader in industrial sensor technology and a pioneer in electrical explosion protection, Pepperl+Fuchs has been developing components and solutions for over 70 years. Above all, our goal is to offer the perfect solutions for our customers' applications. This is only possible with close collaboration. Not only do we share our passion for automation with customers—we also share our in-depth expertise and experience.

Forging ahead with new ideas and finding new approaches is what drives us. This is the foundation for technologically advanced solutions that are tailored to individual applications and geared toward future requirements.

Creating customer-focused solutions to meet today's and tomorrow's challenges is at the center of everything we do. And Industry 4.0 makes this more important than ever. Pepperl+Fuchs is re-envisioning tried-and-trusted technologies and developing innovations that pave the way for networked production and communication that transcends your company's boundaries. Our innovation, your competitive advantage.

For more information, visit us online:
www.pepperl-fuchs.com

Pepperl+Fuchs—Your Partner for Industrial Automation

For over 70 years, Pepperl+Fuchs has relied on the highest quality standards in the development of innovative technologies. Along the way, we have become a global leader in industrial sensor technology—with a comprehensive portfolio that offers the perfect solution for almost any application.

Industrial Sensors from Pepperl+Fuchs

Five sensor technology centers, 500 development engineers, and more than 35,000 products—these numbers illustrate our technological expertise and constant endeavor to advance innovative ideas to perfection. After all, the ever-increasing demands of dynamic, competitive markets make high-performance technologies a key factor to your success.

Decades of experience across all industries have made Pepperl+Fuchs a globally trusted partner in factory automation. The breadth of our portfolio not only provides the right sensor for a wide range of standard applications. In close consultation with you, our experts will develop individual solutions, tailor-made to your unique application.

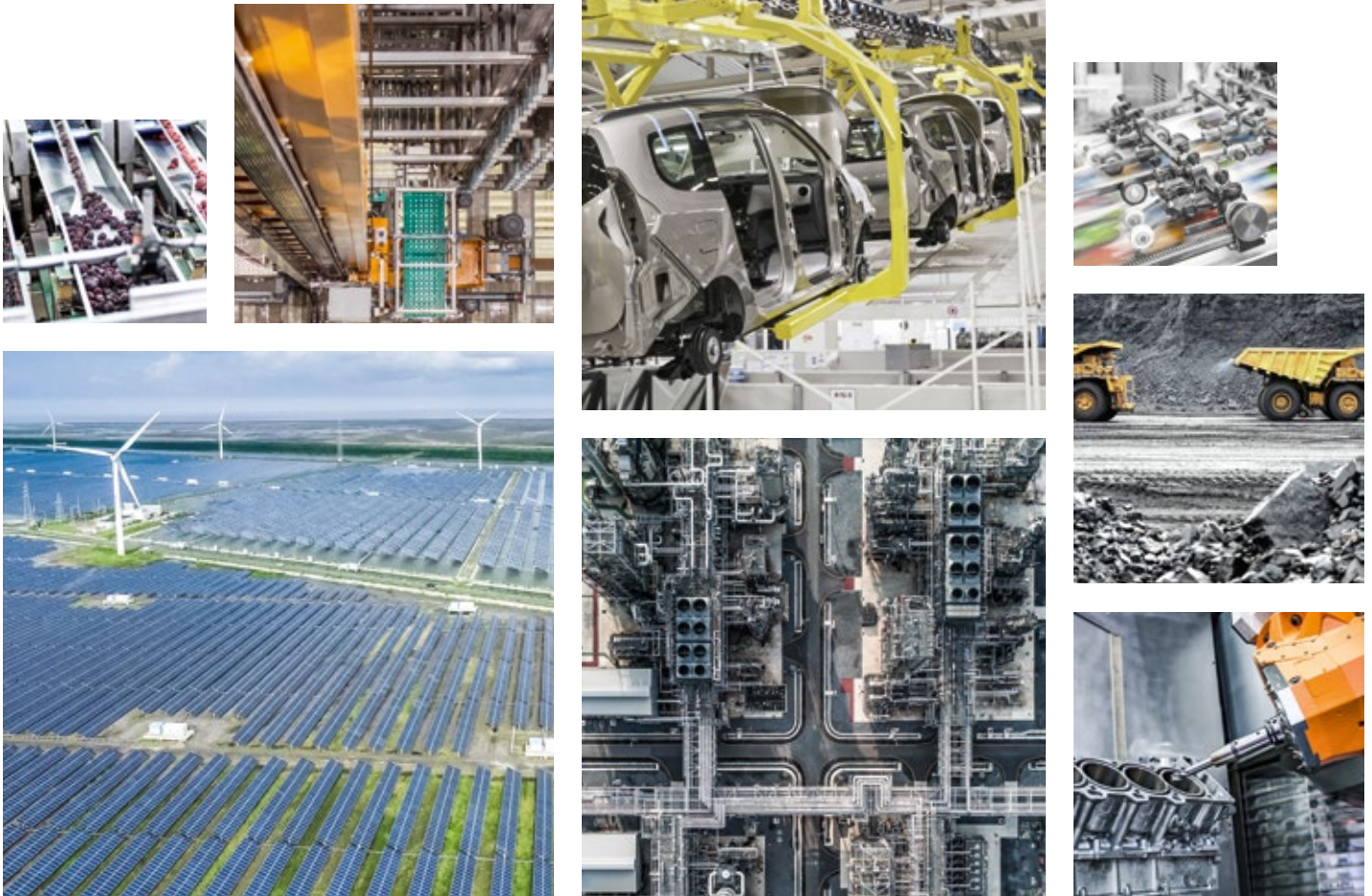

Key Partners in the Pepperl+Fuchs Group



VMT GmbH: Advanced Vision Systems

With 20 years of experience in vision, laser measurement technology, and vision-guided robotics, VMT Vision Machine Technik Bildverarbeitungssysteme GmbH is one of the leading international vision technology providers. We offer customers a broad portfolio of standard and customized vision solutions. As a competence center for vision in the Pepperl+Fuchs Group, VMT offers the most advanced technologies combined with absolute investment security.

www.vmt-vision-technology.com



Neoception GmbH: Custom IoT Solutions

On the path to the digital future, Neoception GmbH is your partner of choice. Our tailor-made industrial IoT services turn conventional products into networked applications. Secure, high-availability infrastructure enables efficient implementation of digital applications and IoT solutions that prepare you for the future—everything you need to profit from networked processes.

www.neoception.com



ecom: Solutions for Mobile Safety and Communication

With ecom, Pepperl+Fuchs gained a highly specialized partner that has been firmly established for decades across many industrial markets—the world market leader for industrial mobile phones, smartphones, and tablets for hazardous areas. With solutions for mobile safety and communication, customer applications can be simply and quickly digitized. This opens completely new possibilities and increases safety, efficiency, and transparency of workflows. Conventional applications are managed perfectly, and everything is in place for Industry 4.0 applications.

www.ecom-ex.com

Industry 4.0: New Paths, New Possibilities

Fully networked systems and communications across all hierarchy levels—the concept of Industry 4.0 offers enormous opportunities but also creates significant challenges for the automation industry.

Industry 4.0: New Challenges for Automation

The scenario of fully networked systems is defined by data communication, both within production processes and to higher-level information systems beyond the physical walls of the plant. In such networked systems, communications take place at any time and between any participant and at any hierarchy level. But the status quo in many production facilities is still traditional machine communication to the control level. We are developing sensor solutions that help companies clear a path to Industry 4.0.

Sensorik4.0®: Sensors That Can Communicate

Fully networked production calls for smart sensors that can communicate data horizontally within production processes and vertically to higher-level MES or ERP systems—even outside company boundaries. Sensors with the ability to communicate are a key feature of Sensorik4.0®: with this concept, Pepperl+Fuchs creates innovative sensor solutions for use in Industry 4.0 scenarios.

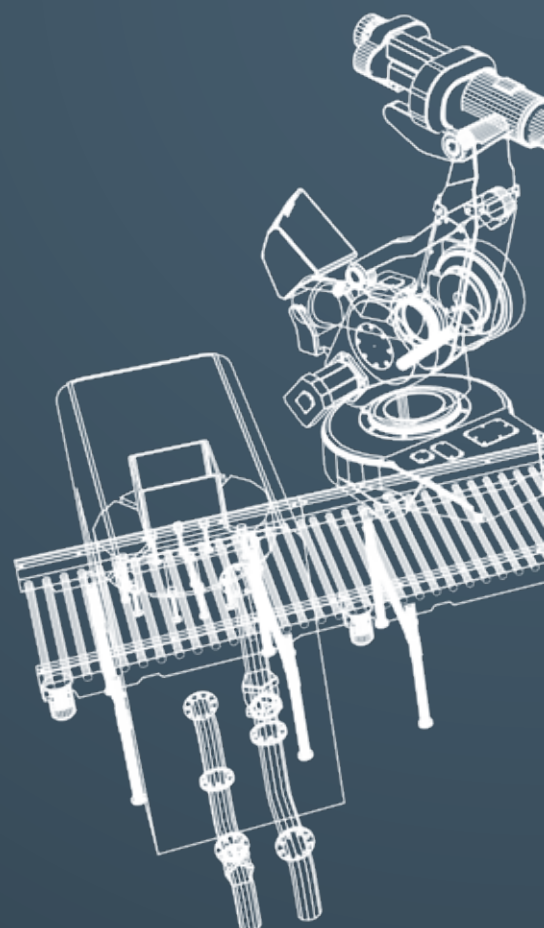

For more information, visit
www.pepperl-fuchs.com/fa-sensorik40

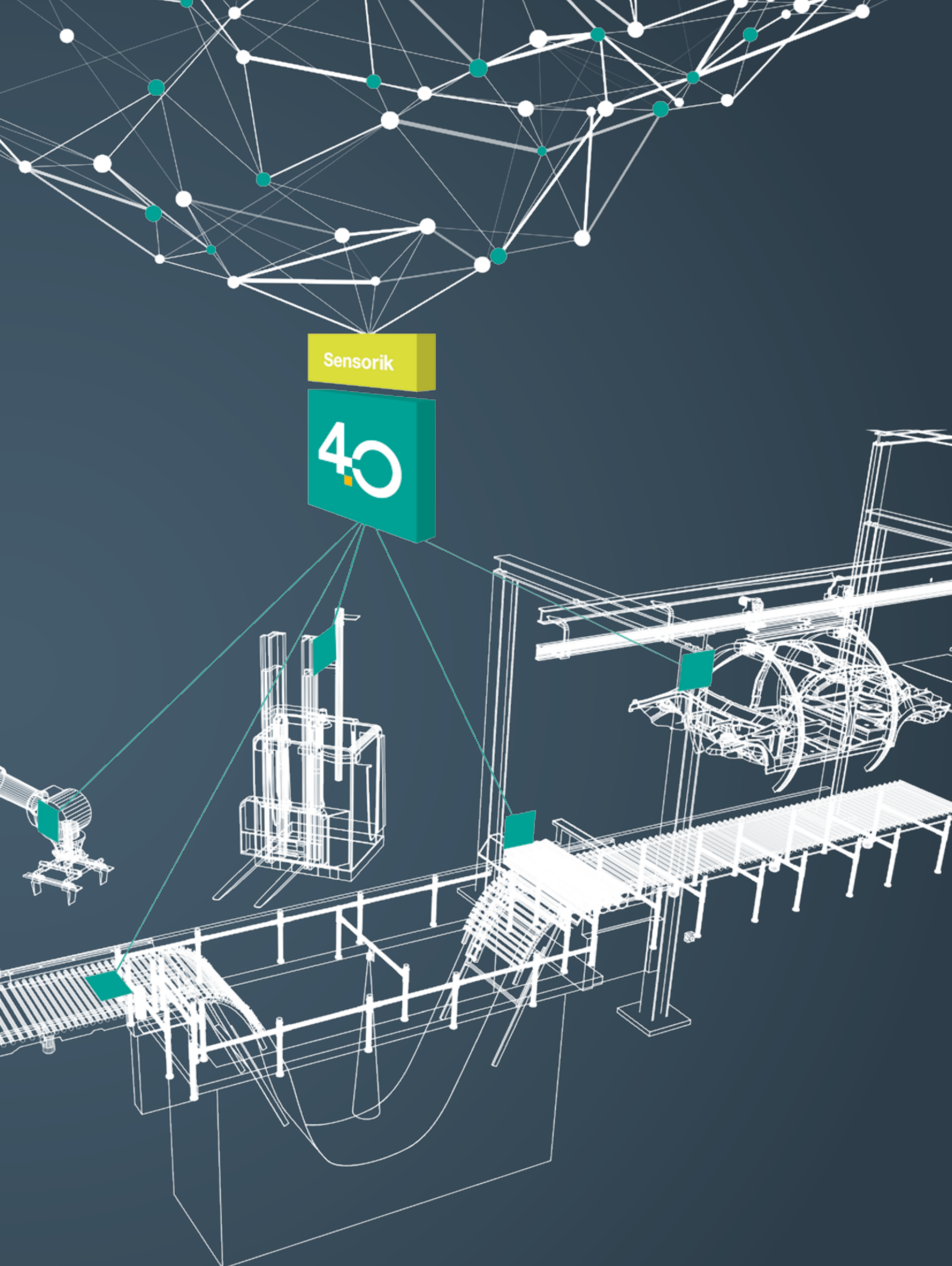

Sensorik

40

Intelligent Sensor Technology— Future-Proof Thanks to IO-Link

Faster commissioning, maximum transparency down to the sensor/actuator level, and preventive maintenance—IO-Link technology enables access to valuable status data for optimally networked production systems in line with Industry 4.0. The basis: Pepperl+Fuchs' portfolio of IO-Link devices.

Efficient Communication down to the Field Level

Developed as a manufacturer-independent standard technology, IO-Link puts the intelligence of sensors to work. The technology enables access to process data and valuable status data, allowing wear or contamination to be identified before it causes problems. With predictive maintenance, you can avoid costly downtime.

In addition to such Industry 4.0 scenarios, IO-Link already offers countless advantages. For example, it simplifies commissioning and device replacement and allows comprehensive diagnostics down to the sensor/actuator level.

Complete Solution from a Single Source

To help you take full advantage of this technology, Pepperl+Fuchs offers a complete solution. In addition to IO-Link sensors with different sensing technologies, other components are available: USB masters for parameterization, Ethernet IO modules with IO-Link master for connection to fieldbus systems, and the SmartBridge® that allows direct access to valuable status data for the first time.

Key Benefits

- Flexible selection of IO-Link sensors with different sensing technologies from Pepperl+Fuchs' growing portfolio
- Complete solution from a single source: compatible IO-Link master for easy integration
- Comprehensive diagnostics and configuration down to the sensor/actuator level
- Simplified device replacement and commissioning: automatic transfer of parameters when connecting new sensors
- Simple and efficient wiring with unshielded standard cables
- Future-proof with IO-Link standard



For more information, visit
www.pepperl-fuchs.com/fa-io-link

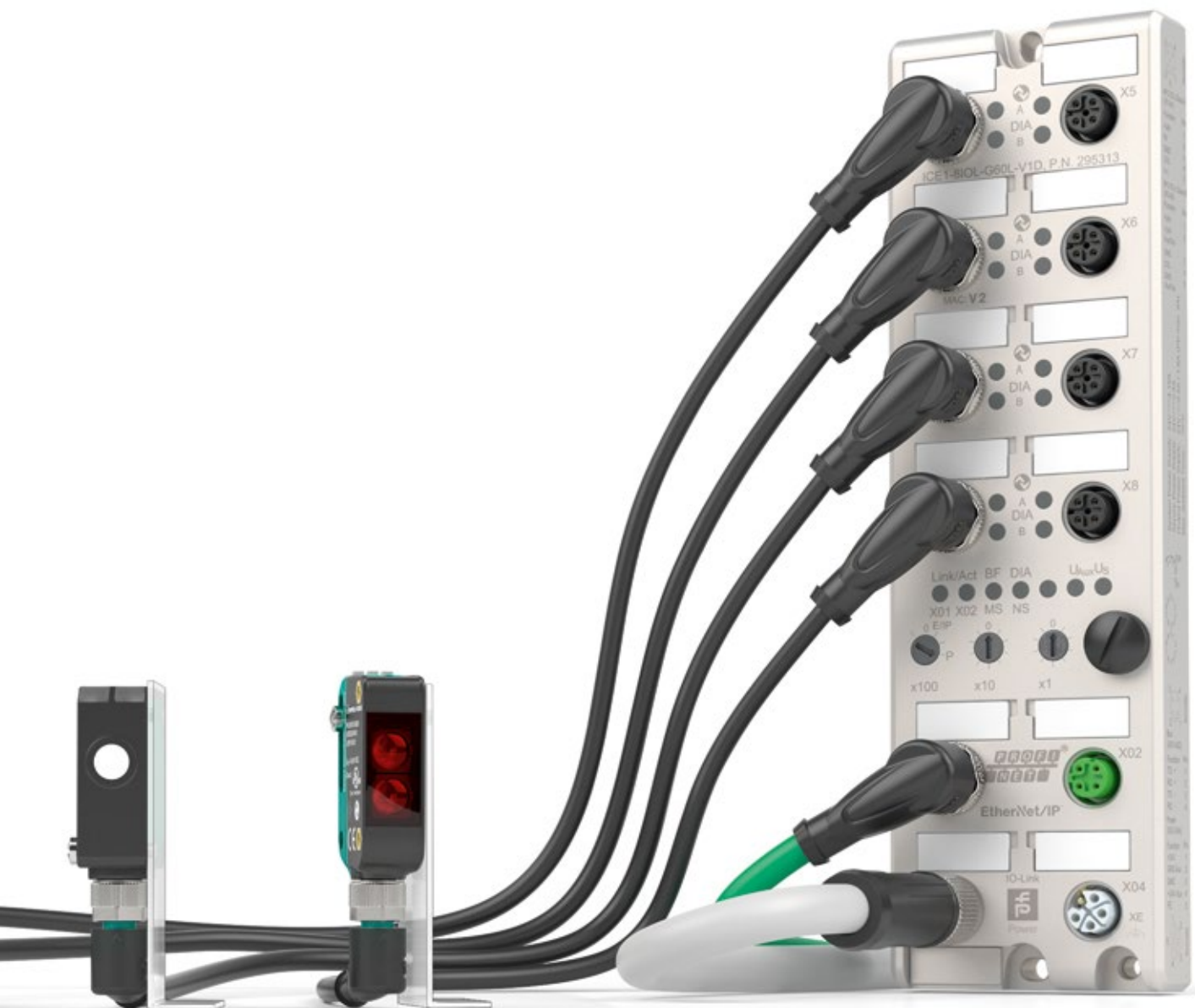

Proximity Sensors

The Best Sensing Solutions— Directly from the Inventor

As the inventor of the proximity sensor, Pepperl+Fuchs has continually developed and perfected this noncontact, wear-free technology. Leveraging decades of experience, we have built a comprehensive portfolio of inductive, capacitive, and magnetic sensors that offers the perfect sensing solution for every application.

Quality beyond the Standard

Pepperl+Fuchs' proximity sensors are known for innovative features, reliability, and the highest quality standards. As pioneers in sensing technology, we see it as our responsibility to offer customers unrivaled quality. With test criteria far beyond standard requirements, we set new benchmarks in performance and longevity.

Practical Expertise since 1959

Starting with the invention of the proximity sensor in 1959, Pepperl+Fuchs has the most experience in this field. Our customers benefit from a global sales and support network and the technical expertise we have developed solving countless applications over the years. Building on this experience, we are focused on the future and constantly developing new technologies. We offer products that exceed even the most challenging application requirements.

Customer-Specific Solutions

Custom solutions round out our portfolio. If the right sensor or feature is not already available in our standard product range, our experts will work with you to develop a solution that fits your application. This is one way that we strive to offer the best sensing solution for every application.



For more information, visit
www.pepperl-fuchs.com/fa-proximity



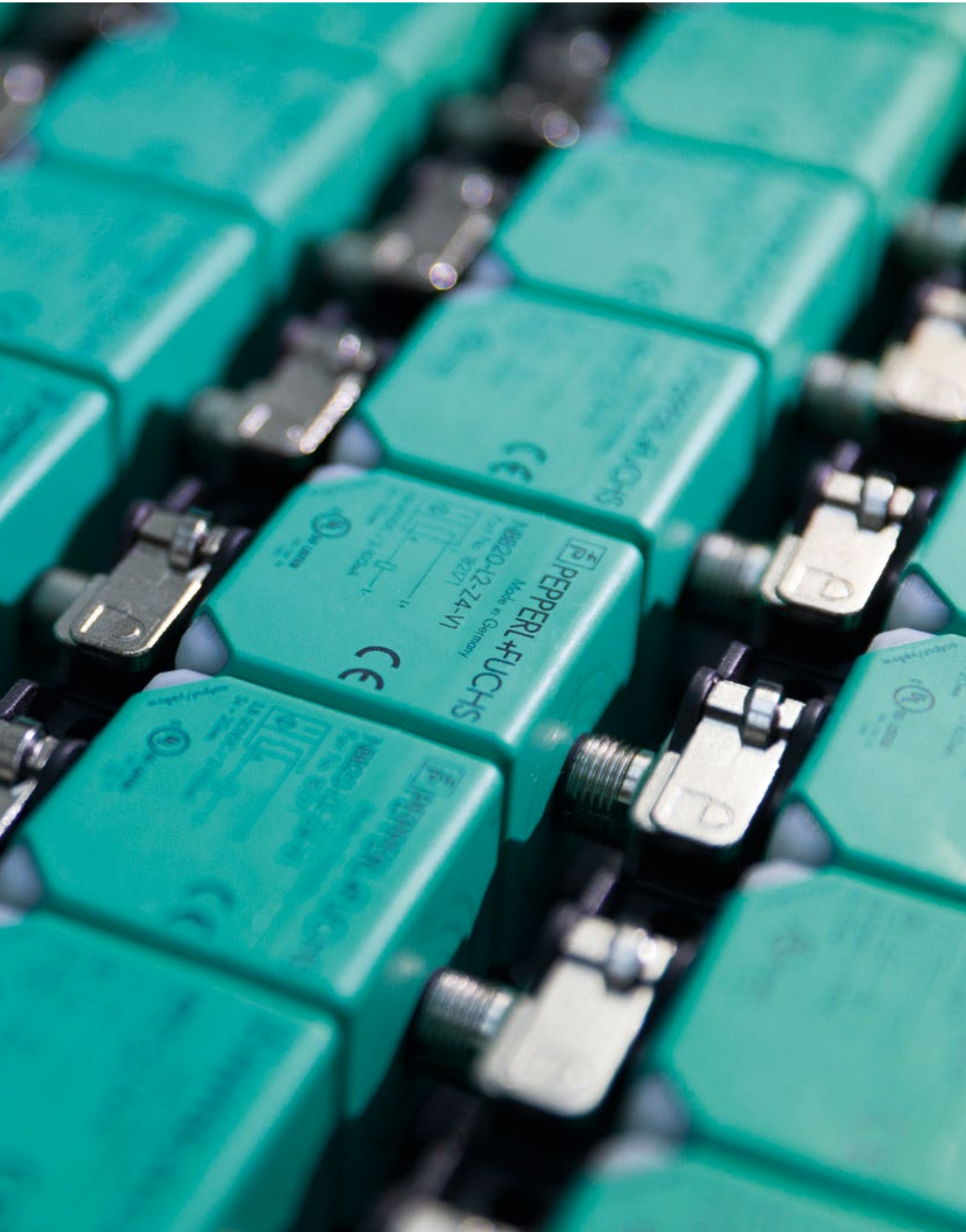

Inductive Proximity Sensors

Comprehensive Portfolio and Individual Solutions

Our complete portfolio of inductive proximity sensors is just as diverse as the customers and industries we serve. With global certifications, a wide variety of technologies and features, and an array of product designs and materials, our selection of over 6,000 sensors makes it easy to find the perfect sensing solution.



Typical Applications

- Wear-free, noncontact detection of metallic objects at distances of up to 100 mm
- Position detection in machine tools
- Monitoring end positions—e.g., in crane applications
- Positioning of skids or trays in automotive production

Key Benefits

- Reliability for your applications with the highest quality standards
- A complete portfolio provides the perfect sensing solution for every application
- Customer-specific solutions complete our standard portfolio
- Special sensors deliver maximum ruggedness and durability for harsh environments
- Application-oriented service and support, in-house development and production, and the most experience in this field

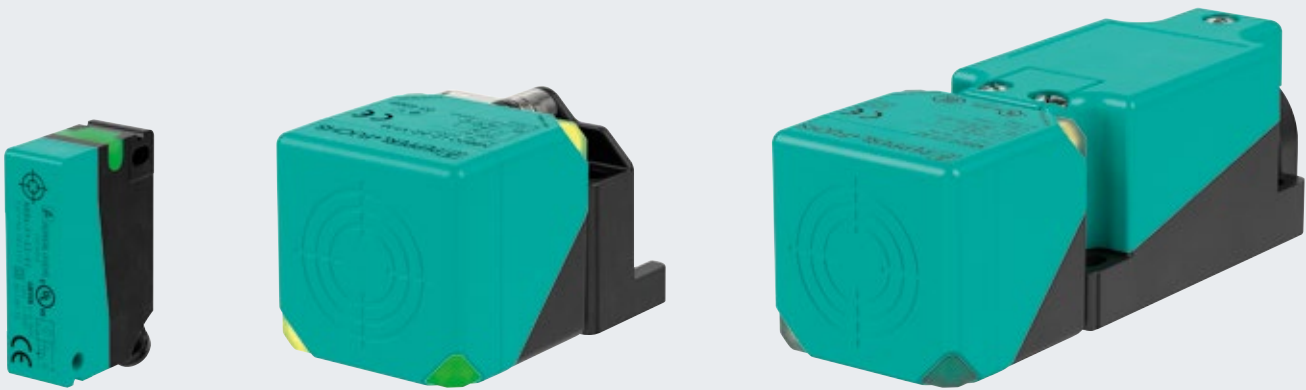

Technical Features

- The largest selection of global certifications, including country- and industry-specific approvals (e.g., KOSHA, NEPSI, GL/DNV, UL, CCC, ATEX, IECEx, EAC-Ex, E1, and SIL)
- Sensors for all supply voltages (DC, AC, universal current) and output signals—discrete (two-, three-, and four-wire), analog, IO-Link, AS-Interface, and NAMUR
- Large selection of designs and materials
- Complete range of cable and connector types
- Variety of specialty features, including metal-face sensors and reduction factor 1
- Sensing ranges up to 100 mm

Inductive Proximity Sensors

Specialized Sensors for Special Applications

From welding operations in automotive production to severe temperature fluctuations in mobile applications to strict safety requirements in hazardous areas—Pepperl+Fuchs offers the right sensors to meet every challenge.

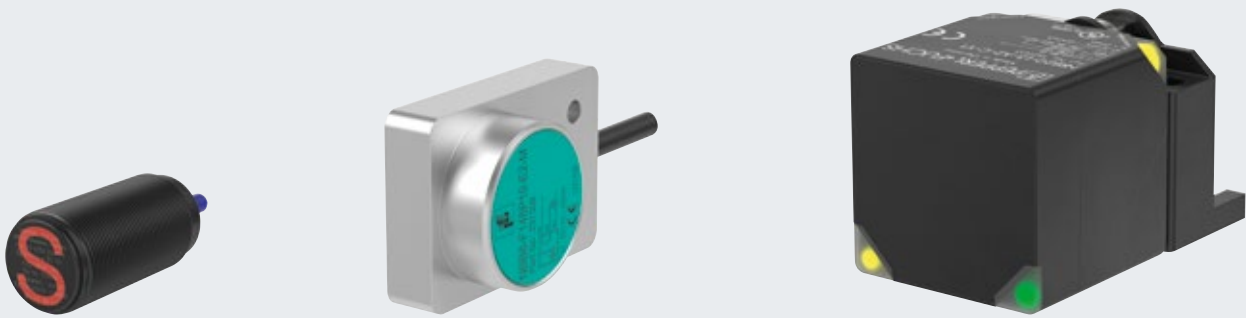

Industry-Specific Special Sensors

Beyond our comprehensive standard portfolio, different industries pose different challenges for sensor technology. Three extreme examples are the automotive industry, mobile equipment, and the process industry, where intrinsically safe NAMUR sensors are used.

Typical Applications

- Position sensing for weld areas in automotive production
- Valve position monitoring in hazardous areas
- Monitoring of supports on mobile cranes

Key Benefits

- Largest portfolio of sensors for explosion protection with global approvals (including ATEX, IECEx, EAC-Ex), e.g., in the process industry
- Weld-resistant sensors for maximum durability in automotive production
- Pressure-resistant sensors for maximum resistance in hydraulic cylinders
- Highly resistant sensors with E1 approval for use on public roads and in the mobile equipment industry
- Reduction factor 1 sensors provide the same operating distance with any metal, for maximum flexibility in machine building



Proximity Sensors in Special Designs

In addition to industry-specific solutions, sensors often have to be adapted to specific installation requirements. Along with numerous cylindrical and cube-style housings, our portfolio also includes special designs that have been designed for specific applications.

Typical Applications

- Ring-shaped proximity sensors for small-parts detection or level detection
- F58 housing: detection of two different target positions in space-restricted applications—e.g., on power clamps

Key Benefits of Selected Sensors

Ring-Shaped Proximity Sensors in RC/RJ Housing:

- High accuracy for reliable detection of even the smallest parts
- High throughput speed of up to 10 m/s
- Bistable models with direction detection available
- NAMUR versions with hazardous-location approvals for Zone 1 available

F58 Housing for Power Clamps:

- Special housing design with two sensors connected by flexible cable to the main housing
- Flexible installation with rotating M12 connectors
- Many sensor housing designs available for space-restricted installations
- Easy diagnostics with highly visible LED band

Capacitive Proximity Sensors

The Perfect Solution for Nonmetallic Objects

For liquids, powders, wood, and other materials that inductive sensors cannot handle, capacitive sensors are the perfect choice. With specialty sensors made from stainless-steel and chemically resistant materials, our sensors ensure maximum reliability and durability.

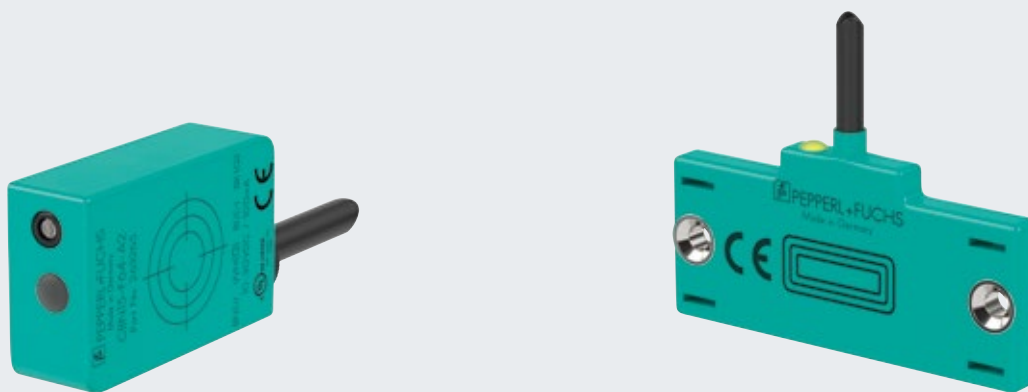

Typical Applications

- Level measurement of liquids and solids in the agricultural and woodworking industries
- Detection of materials in plastic containers
- Chemical and pharmaceutical process engineering
- Medical and rehabilitation engineering
- Woodworking machinery
- Glass and plastic processing

Key Benefits

- Reliability for your applications with the highest quality standards
- Perfect solution for detecting nonmetal objects
- Maximum ruggedness and durability for harsh environments
- Application-oriented service and support at the highest technical level

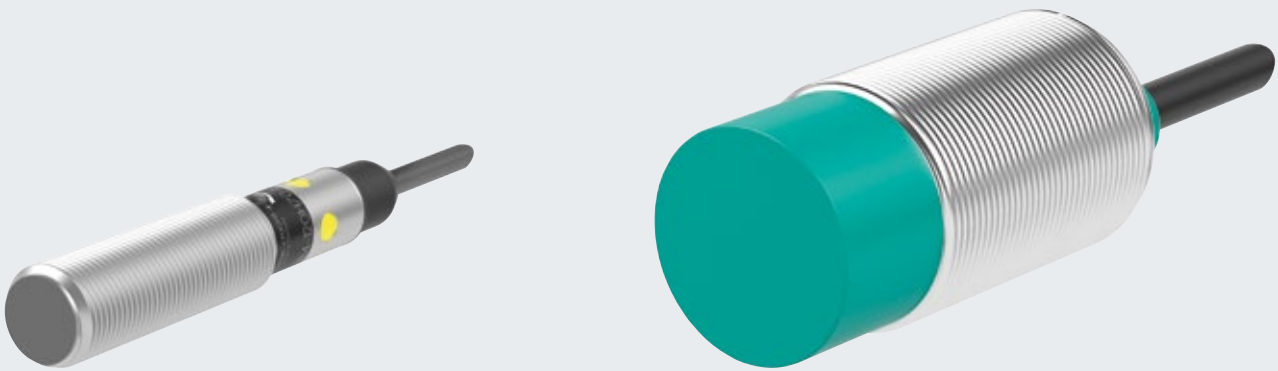

Technical Features

- Sensors for all supply voltages (DC, AC, universal current) and output signals—discrete (two-, three-, and four-wire), AS-Interface, and NAMUR
- Complete range of cable and connector types
- Variety of special approvals, including for explosion protection
- Robust sensors with stainless-steel and chemically resistant housings
- Sensing ranges from 1 mm to 50 mm

Proximity Sensor Applications

Special Sensors for the Process Industry

Pepperl+Fuchs offers a large selection of sensors that are specially developed for the demands of the process industry. Open solutions for valve position monitoring are a highlight of this portfolio: from standard to extreme applications, these sensors are easy to operate and ensure maximum reliability.

Over 60 Years of Experience in the Process Industry

For more than 60 years, the name Pepperl+Fuchs stands for quality products, services, and solutions for process plants in hazardous locations. Decades of experience, application expertise, and constant dialogue with our customers are the basis for our comprehensive portfolio, tailored to this industry's unique requirements.

Open Solutions for Valve Position Monitoring

Standard pneumatic valve actuators typically use sensors to detect the current valve position and transmit it to a control panel. Along with box solutions and inductive positioning systems, a highlight of Pepperl+Fuchs' portfolio is open solutions for valve position monitoring. Mounted directly on valve actuators, these dual sensors always maintain an assured sensing range. They are completely wear-free and ensure absolute reliability.

The Right Solution for Any Application

Our portfolio consists of three series that can be used with one or two actuators, depending on the size of the actuator. This makes it easy to find the optimal solution for any application.

The **F25/F25K** series is available with cable, plug, or plug-in terminal connections and combines two sensing elements in one compact housing. It is perfect for smaller, basic applications, such as hand valves in indoor areas.

The **F31/F31K** series is used on standard valve actuators in indoor and outdoor applications. It is easy to install, and a hazardous-location model is also available.

The **F31K2** series is specially designed for outdoor use. It offers flexibility, durability, and outstanding performance—even the most extreme conditions.

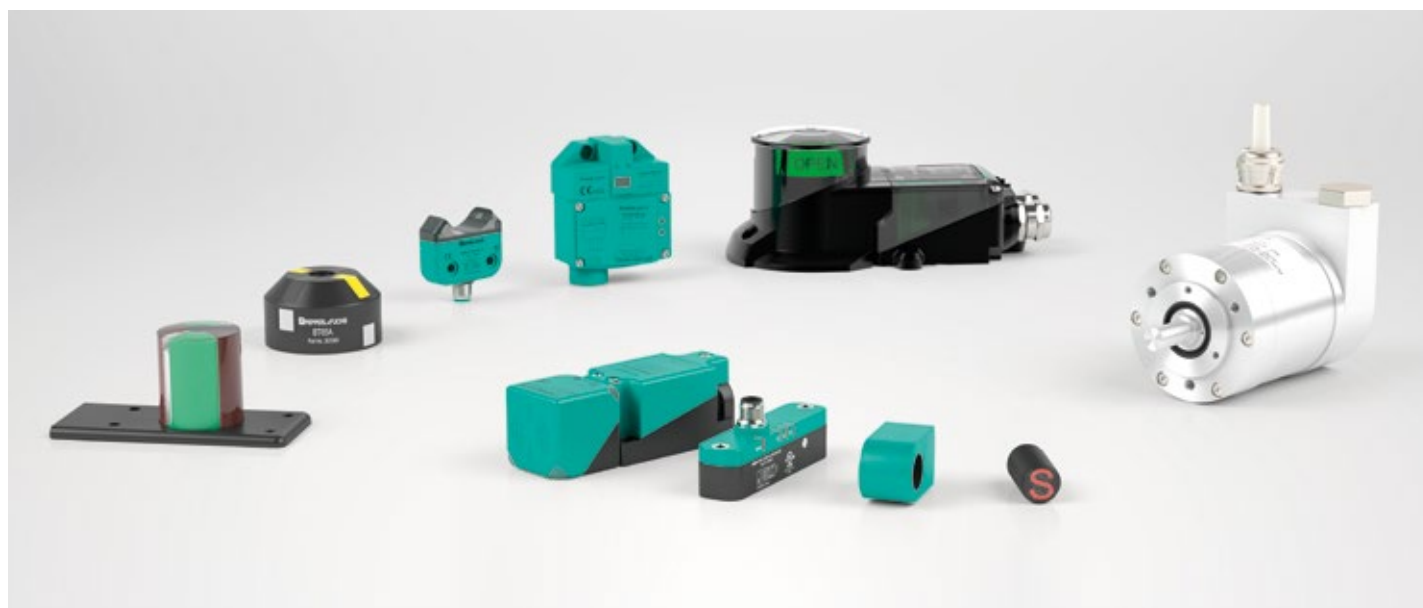

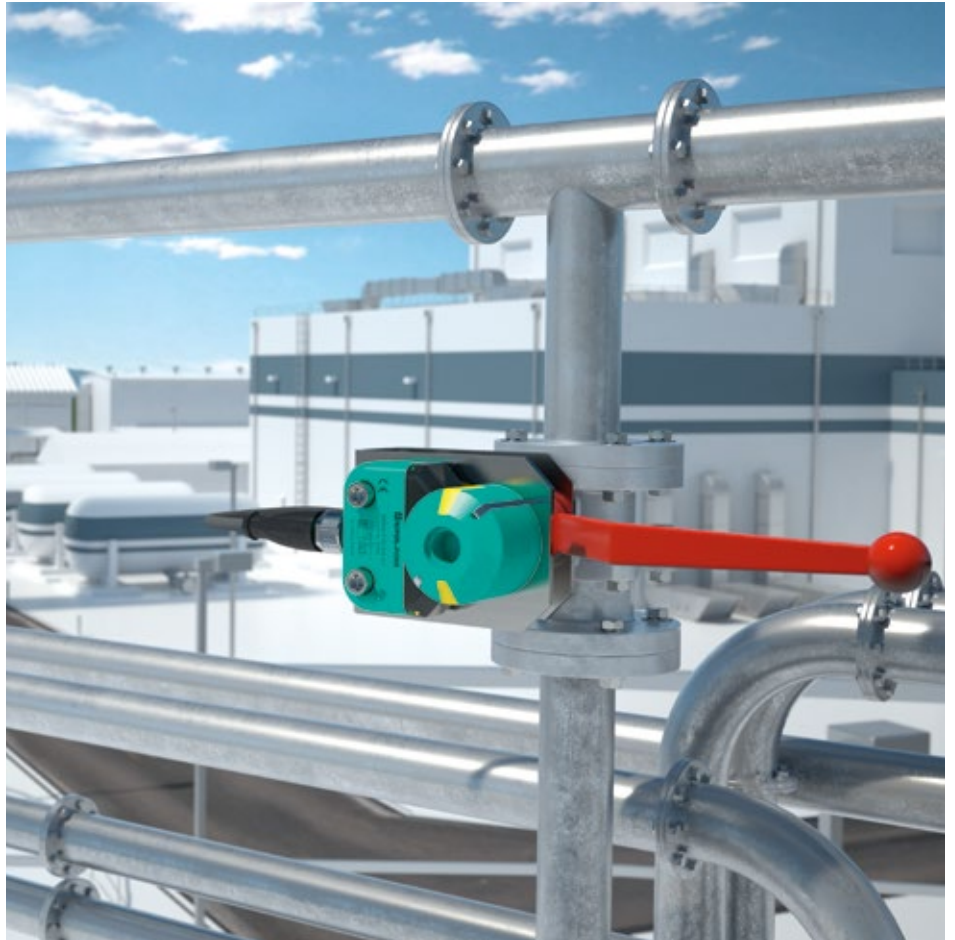

F31K2 Highlights at a Glance

- Simple mounting on standard actuators
- Open solution with widely visible valve position display and translucent housing
- Flexible, modular housing design
- High impermeability due to noncontact, inductive valve position detection
- Optimized for outdoor use with high UV, temperature, and saltwater resistance

For more information, visit
www.pepperl-fuchs.com/fa-process



Photoelectric Sensors

Advanced Technologies for Efficient Applications

Innovative sensor solutions that are driven by decades of experience and continual development—these are the hallmarks of photoelectric sensors from Pepperl+Fuchs. Advanced technologies like Pulse Ranging Technology, Multi Pixel Technology, and universal IO-Link integration maximize the efficiency of your applications.

Innovations for Industrial Automation

With the development of Pulse Ranging Technology (PRT), Pepperl+Fuchs introduced time-of-flight measurement to the commercial industrial market. R2000, the world's first 360° 2-D LiDAR sensor, revolutionized navigation of automated guided vehicles. With innovations like these, Pepperl+Fuchs has been shaping the world of automation right from the start. Continual development will bring about even more cutting-edge solutions in the future.

A Portfolio Built around Your Requirements

Tailored to the requirements of industrial automation, our portfolio of photoelectric sensors offers the right solution for any application. A variety of sensing modes are available in miniature, standard, and special designs—from classic thru-beam sensors to diffuse-mode sensors to high-performance distance sensors.



For more information, visit
www.pepperl-fuchs.com/fa-opto



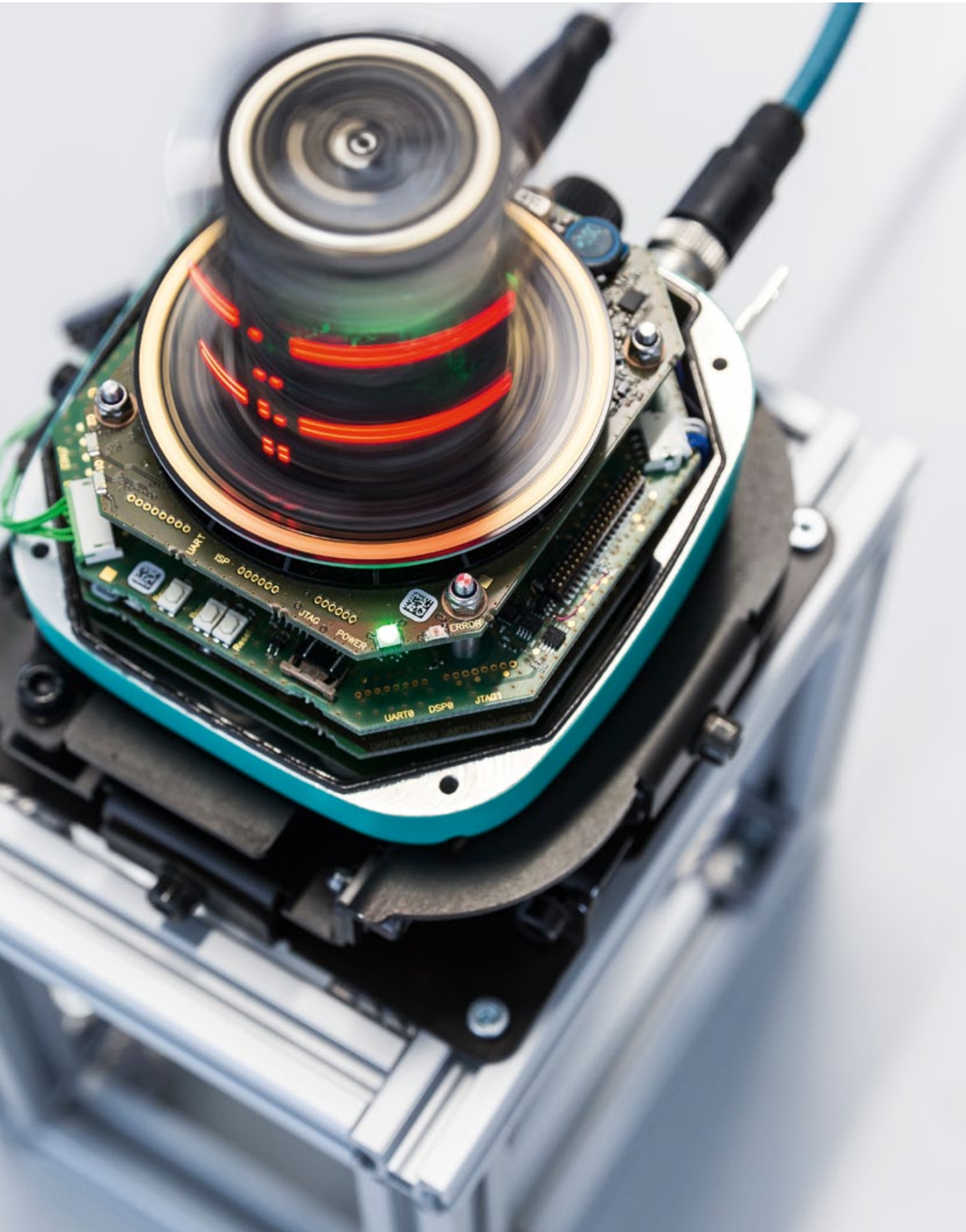

Photoelectric Distance Sensors

Absolute Precision with Pulse Ranging Technology

Whether the application calls for a photoelectric distance sensor in a standard housing or an advanced 2-D LiDAR sensor, PRT is the perfect solution for reliable, high-precision distance measurement.



2-D LiDAR Sensors

Our optimized portfolio of 2-D LiDAR sensors includes a range of solutions, from basic to high-end applications. R2000 series 2-D laser scanner sensors with a 360° measuring angle offer maximum performance in the most compact housing design. The R2100 Multi-Ray LED Scanner provides durability and economy.

Typical Applications

- Navigation of automated guided vehicles
- Profile measurement in robotics applications
- Collision avoidance on stacker cranes and overhead conveyors
- Overhang detection on pallets
- High-precision monitoring of large areas

Key Benefits of Selected Sensors

R2000 UHD 2-D Laser Scanner:

- Sharp, pinpoint light spot allows detection of small objects, reflectors, or edges
- 360° measurement for all-round visibility and a detection range up to 100 m
- Suitable for high-speed applications due to a rapid scan rate of 100 Hz
- Best angular resolution on the market of 0.014° ensures extremely accurate detection

R2100 Multi-Ray LED Scanner:

- LEDs ensure long service life
- No moving parts for added durability in challenging environments
- 2-D measurement via 11 individual beams
- Multiple wide-beam emitters ensure reliable object detection regardless of surface texture

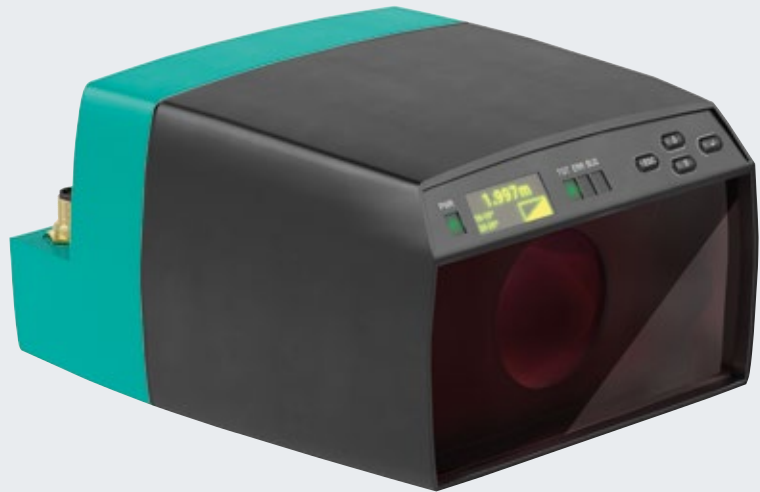

1-D Distance Sensors

Equipped with innovative PRT, Pepperl+Fuchs distance sensors detect objects at distances of a few centimeters to up to several hundred meters. With intelligent sensor electronics, PRT allows high-precision, reliable, and clear measurements with high repeatability and high switching frequencies—even with challenging environments and object surfaces.

Typical Applications

- Positioning of stacker cranes, gantry cranes, and shuttle cars
- Level measurement
- Empty bay detection in warehouses
- Stack height control
- Thickness measurement of coils

Key Benefits of Selected Sensors

VDM28:

- Dual discrete outputs, available analog output, and IO-Link interface open up a range of applications
- High resistance to ambient light and cross-talk protection
- High repeatability regardless of the surface texture
- Small light spot allows pinpoint detection

VDM100:

- Improved productivity due to high speed and seamless data acquisition
- High reliability with a repeat accuracy of 0.5 mm
- More application possibilities with a detection range up to 300 m and immunity to ambient conditions
- Easy integration in different environments with a wide variety of interfaces: SSI, EtherNet/IP, PROFIBUS, INTERBUS, and RS-422

Standard Photoelectric Sensors

Flexibility Redefined

Multiple sensing modes integrated into identical standard housings—this is the concept behind our portfolio of standard photoelectric sensors. Regardless of the mounting conditions, an appropriate sensor is always available as thru-beam, retroreflective, diffuse mode, or diffuse mode sensor with measurement core technology.



Typical Applications

- Small-part detection
- PCB inspection
- Front-edge detection on conveyors
- Detection of transparent objects
- Object positioning

Key Benefits

- Photoelectric sensing modes integrated into identical standard housings for increased flexibility
- Available in a variety of cube-style and cylindrical housing styles
- Innovative DuraBeam laser technology for long service life and increased operating temperature range—also available in ultracompact housing designs
- Communication to the sensor level with IO-Link

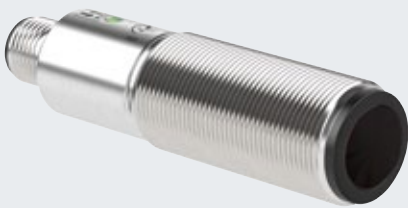

Technical Features

- Complete portfolio of sensing modes available: thru-beam, retroreflective, and diffuse mode, as well as special modes, such as diffuse mode with measurement core technology (available in the R10x series and others)
- A variety of light sources (red light, infrared, and laser) for optimal adaption to any application
- Comprehensive accessories, including mounting brackets, reflectors, and alignment aids
- Environmental protection up to IP69K



Multi Pixel Technology (MPT) for Precise Close-Range Distance Measurement

Distance sensors are also available in small to medium-sized standard housing designs. The compact size of the measurement core enables highly precise, reliable, and adaptable distance measurement for close-range applications.

For more information, visit
www.pepperl-fuchs.com/fa-mpt



Light Grids

Easily Integrated Object Detection

Pepperl+Fuchs light grids are easy to install, commission, and operate. Software-free parameterization via touch field and the ability to choose between 16 integrated measuring options (on the LGM model) make integration easier than ever before.

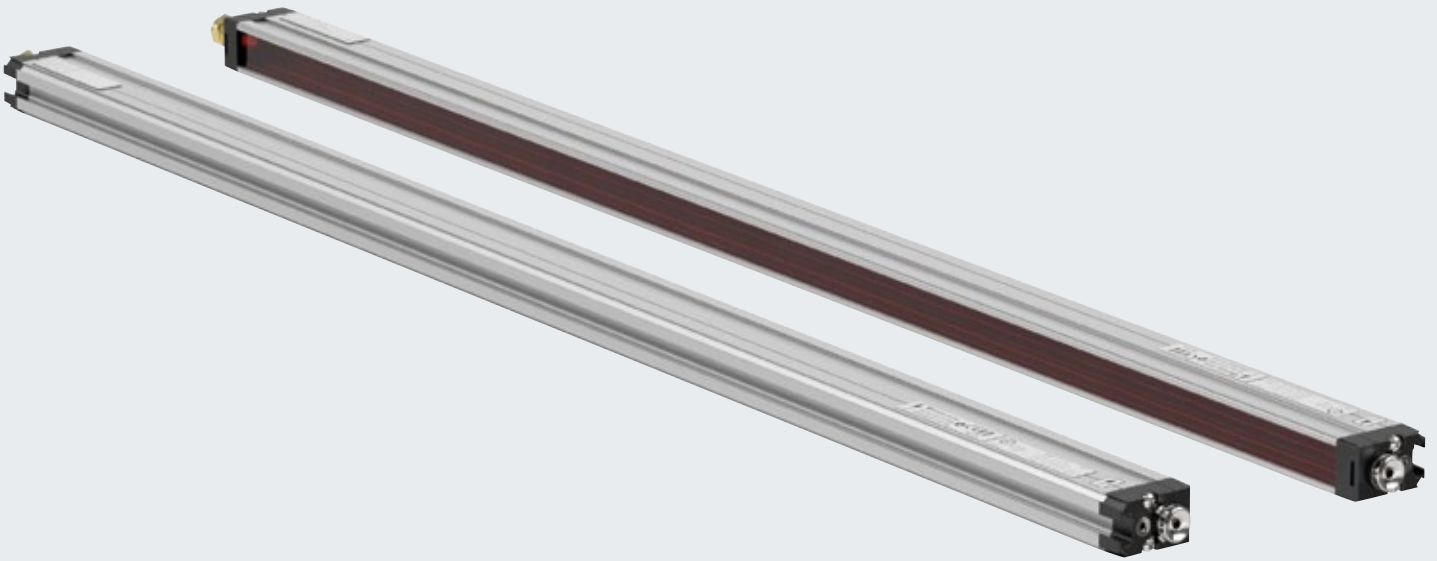

Typical Applications

- Height and object detection in the packaging and material handling industries
- Detecting and counting irregular objects
- Positioning and measuring objects
- Object detection independent of object shape
- Object identification

Key Benefits

LGS Light Grid:

- Simple, software-free parameterization via touch field or external input
- Ultrafast object detection—even with three-way beam crossover
- IO-Link interface for service and process data
- Object identification using integrated object recognition

LGM Measuring Light Grid:

- Maximum ease of use with 16 integrated measuring functions
- Easy integration with direct measurement output in millimeters—no complex conversions
- Easy setup and evaluation via IO-Link interface
- IP67 protection offers durability

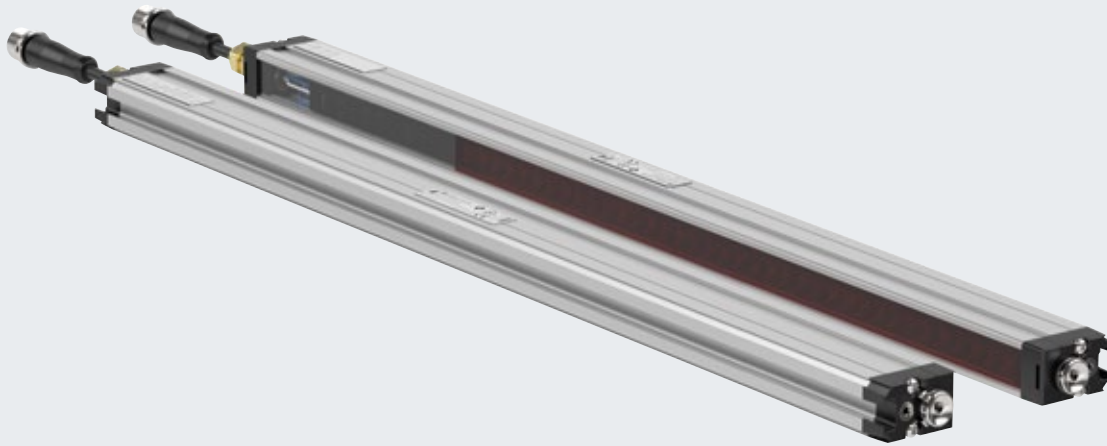

Sensors for Safety Applications

The highest quality standards and reliability for protecting personnel and machines: that is what safety-certified Pepperl+Fuchs sensors stand for. The portfolio has been specially tailored to functional safety requirements and offers excellent investment security and maximum plant availability.

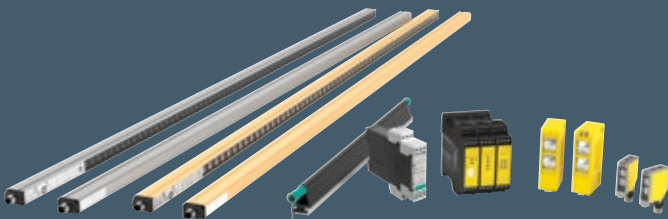

For more information, visit
www.pepperl-fuchs.com/fa-safety



Special Photoelectric Sensors

Optimized for Specific Applications

For applications that go beyond the standard, our portfolio also includes highly specialized sensors. Developed to solve specific applications, these sensors provide optimal solutions to unique challenges.



Fiber Optic Sensors

Typical Applications

- Detection of objects in harsh conditions—involving high temperatures, vibration, or corrosive cleaning agents
- Object detection in space-restricted installations
- Small-part detection

Key Benefits

- Reliable operation in all environmental conditions
- Easy commissioning: via teach-in or potentiometer
- Available with IO-Link interface for easy parameterization (MLV41)
- High-power models available

Technical Features

- Environmental protection up to IP67
- Suitable for plastic and glass fiber optic
- Slim, DIN-rail-mountable housing designs available

Print Mark Contrast Sensors

Typical Applications

- Detection of contrast marks to control printing, labeling, and packaging systems
- Used in the printing, packaging, and food industries

Key Benefits

- Reliable detection even of weak contrast marks with three emitter colors (R, G, B) and separate teach-in for mark and background
- High switch point accuracy with light spots matched to contrast marks
- High switching frequencies for extremely quick scanning processes

Technical Features

- IO-Link interface available for service and process data
- Contrast sensor available in standard industrial housings
- Static or dynamic teach-in



Slot and Slot Grid Sensors

Typical Applications

- Presence detection on feeders
- Ejection control for small parts
- Counting of bulk materials on vibration conveyors
- Small-part detection

Key Benefits

- Optical axes are prealigned for quick installation
- Simplified installation with one single connection
- Variety of housing designs
- High switch point accuracy for high-precision positioning tasks

Technical Features

- Miniature housing designs available—optimized for small-part detection down to 0.8 mm
- Slot width up to 220 mm
- Rugged metal versions available
- Environmental protection up to IP67

Photoelectric Sensor Applications

Optimizing Processes in High-Bay Warehouses

LS682 optical data couplers for fast transfer of process data and R2000 Detection 2-D laser scanners to protect stacker cranes and detect broken pallets: innovative products reduce standstills in high-bay warehouses and dramatically increase the efficiency of the entire system.

Sensors for Material Handling

From logistics centers to warehouses to airports, reliable sensor technology is essential to the smooth flow of materials. Goods need to be transported quickly and reliably to their destinations. Safety and cost-effectiveness are top priorities. Sensor solutions from Pepperl+Fuchs ensure fault-free process sequences in intralogistics, fast throughput times, and optimal utilization of storage space. In addition to a large selection of standard photoelectric sensors and distance sensors, specialized products are also used in high-bay warehouses. Two examples are the LS682 optical data coupler and the R2000 Detection laser scanner.

Wireless Data Transfer of up to 100 Mbit/s (1)

Completely wear-free, the LS682 optical data coupler transmits process data in high-bay warehouses. Installed directly on a stacker crane, stable data transfer is ensured over a distance of up to 300 m with a constant transfer rate of 100 Mbit/s. This prevents machine downtime and increases efficiency.

Protecting Stacker Cranes (2)

The R2000 Detection is mounted on the side of the stacker crane with a radius of up to 30 m and brings the machine to a stop with a switching signal when it detects even the smallest objects sticking out of the bays. This prevents collisions and protects the machine from damage. Its highly stable scanning axis, market-leading angular resolution among digital scanners, and a simple operating concept make it an optimal solution for this application.

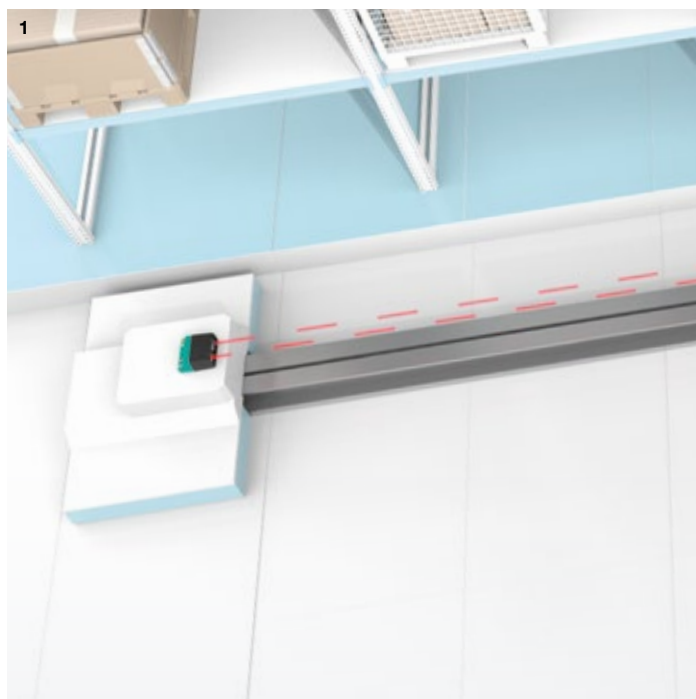

High-Precision Detection of Broken Pallets (3)

Storage and retrieval of pallets can cause damage to the machines and technologies involved. If part of a pallet is broken, the pallet can get stuck or fall down. The R2000 Detection helps prevent this. Mounted underneath the crane fork, it scans the bottom of pallets and, due to its wobble-free scanning axis, it can detect even small overhangs and communicate this to the control panel.

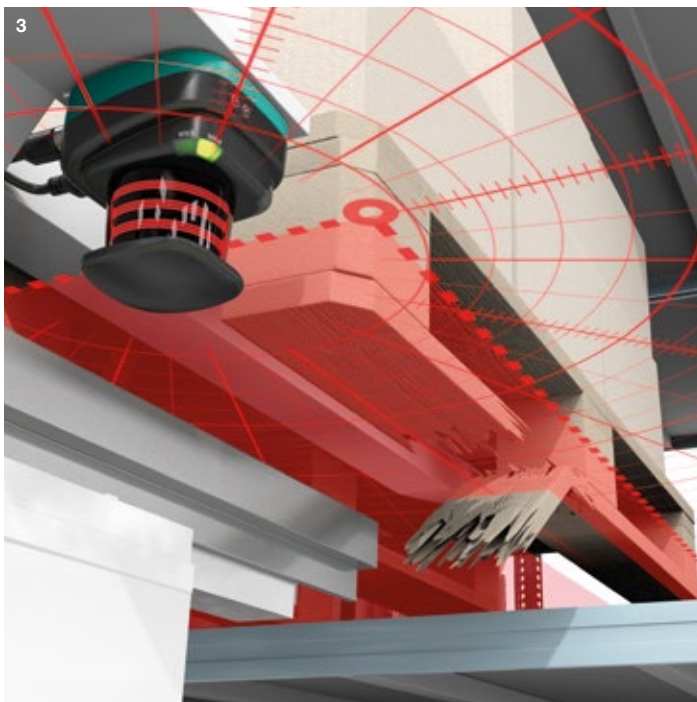
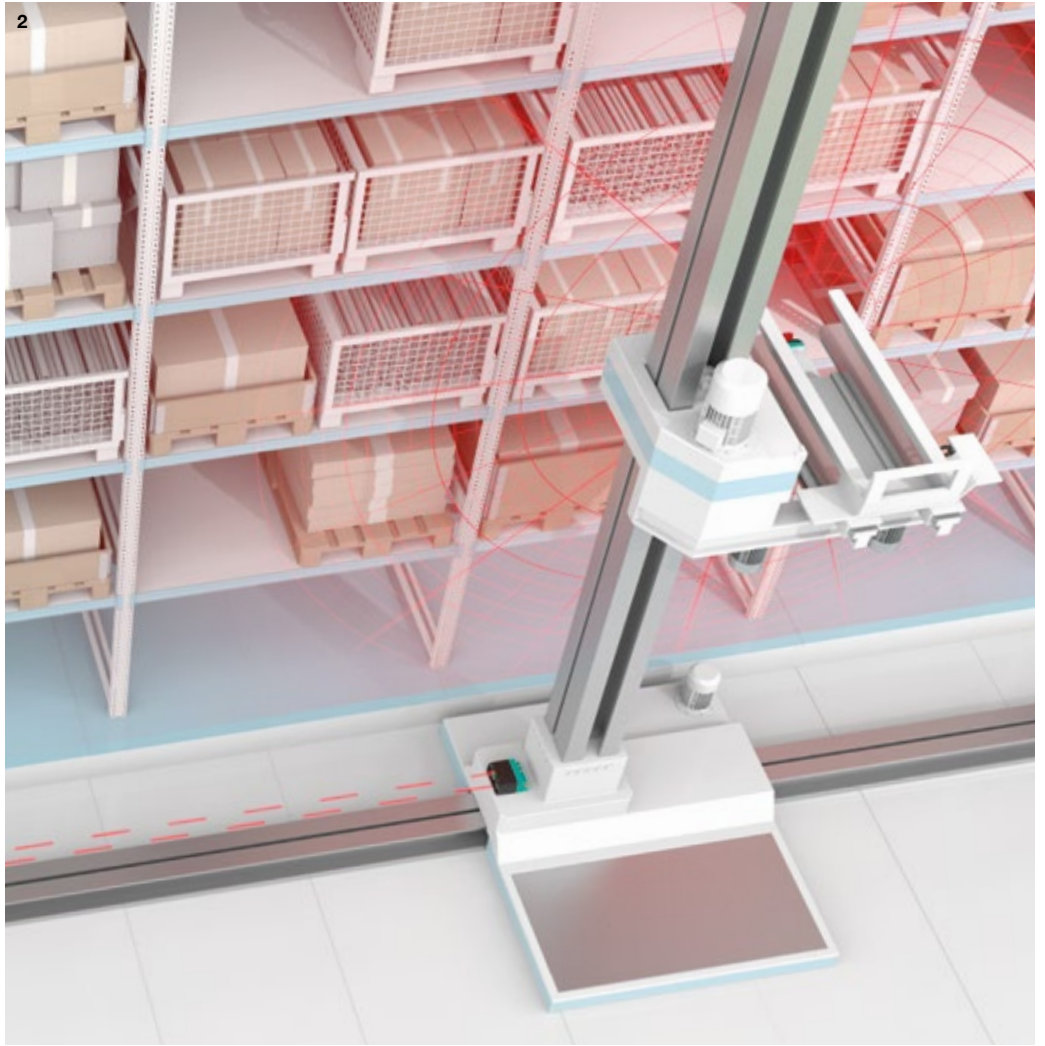

For more information, visit
www.pepperl-fuchs.com/fa-material



Ultrasonic Sensors

Innovation and Expertise Right from the Start

Pepperl+Fuchs' ultrasonic portfolio combines decades of development skills and vertical integration. Our in-house expertise in ultrasonic transducers, an ultrasonic technology center, and comprehensive expert knowledge stand for future-proof and application-oriented sensor solutions.

Top Quality and Performance

Ultrasonic sensors from Pepperl+Fuchs are built in our own technology center, where transducer development and manufacturing take place. For more than 30 years, our forward-thinking team of experts has been working continually to advance ultrasonic technology for the solutions of tomorrow. That means our customers always receive the highest-performing products on the market. This approach has led to the broadest portfolio in the industry—supported by numerous patents and innovations—for the highest level of flexibility in product selection and optimal application solutions. In addition to our standard portfolio, Pepperl+Fuchs has the knowledge and infrastructure to respond to customer requirements with speed and flexibility.

Ultrasonic Sensors for Any Industrial Application

Ultrasonic sensors are used to detect objects and measure distances in industrial applications where versatility and reliability are key. Pepperl+Fuchs offers a wide variety of ultrasonic sensors that feature benefits like minimal dead bands, large measuring ranges of up to 10 m, adjustable sound beams, and much more—and all in a variety of housing designs, so we can always offer reliable and efficient solutions.

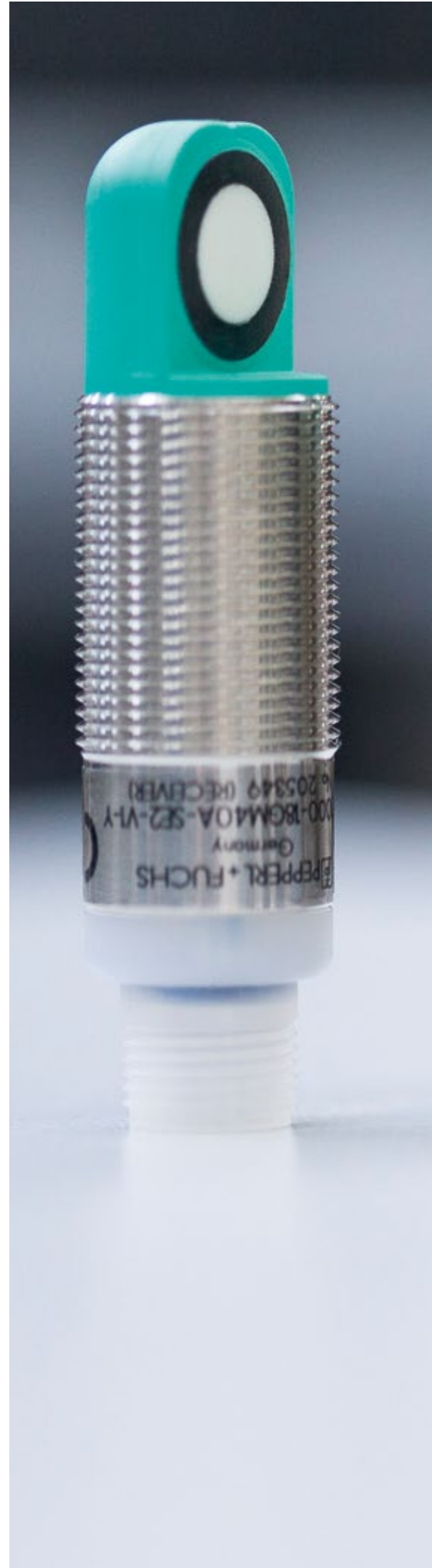

For more information, visit
www.pepperl-fuchs.com/fa-ultrasonics



Standard Ultrasonic Sensors

Complete Portfolio for Industrial Applications

Unique features such as minimal dead bands, long detection ranges, and robust sensor solutions: our broad portfolio of standard ultrasonic sensors combines a wide variety of housing designs and reliable sensing modes for every industrial application.



Typical Applications

The versatility of ultrasonic technology is almost limitless. The wide range of applications is demonstrated by the technology's insensitivity to countless materials, surface types, and colors. Typical applications include:

- Level measurement and control in containers, tanks, or silos
- Applications on mobile vehicles, such as aerial work platforms, forklifts, agricultural, or waste disposal vehicles
- Detection of PCBs, bottles, metal, granulate, foil, lacquers, and paints

Key Benefits

- A comprehensive portfolio of cube-style and cylindrical ultrasonic sensors for flexible application solutions
- Wide range of designs and detection ranges: compact and space-saving housing design and detection ranges of up to 10 m
- Intuitive programming and adjustment options on the device via interface or parameterization software
- For optimal integration, special designs, different transducer versions and comprehensive accessories are available
- Features such as minimized dead bands, synchronization, noise immunity, and IO-Link for reliable processes

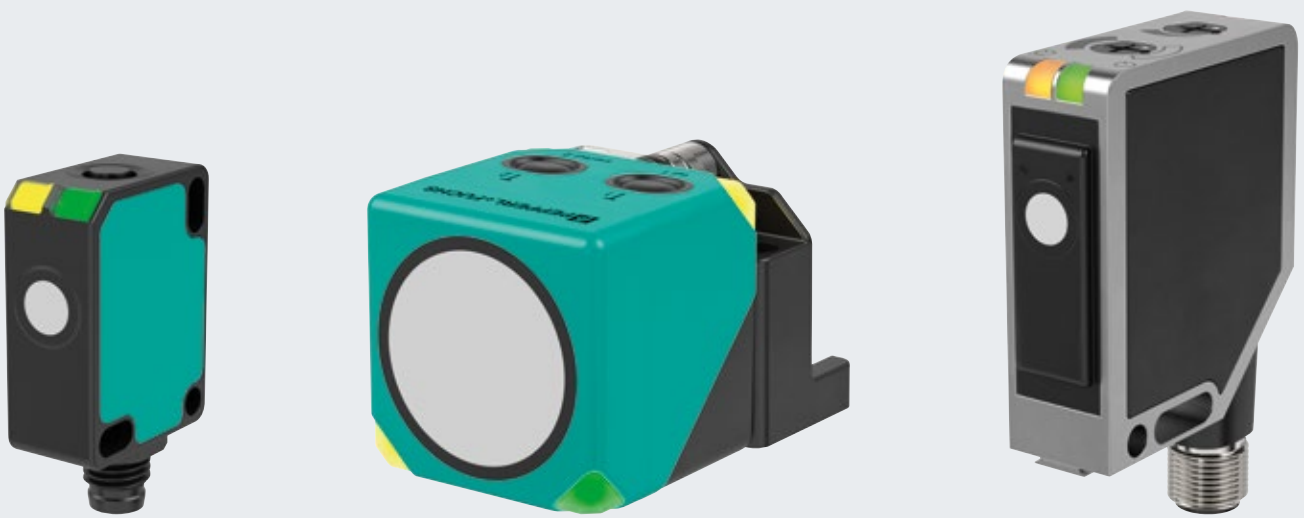

Technical Features

- Automatic sensor synchronization: multiplex or common mode for reliable operation of multiple sensors that are installed in close proximity to each other
- Adjustable sound beam for fault-free performance
- Variety of output types for increased flexibility
- High degree of vibration resistance for use in harsh conditions and mobile applications
- Maximum process reliability through direct access to process data and diagnostics data via IO-Link

Special Ultrasonic Sensors

Robust Design for Extreme Conditions

In addition to standard industrial applications, our portfolio of ultrasonic sensors is well suited to application-specific solutions. It offers maximum flexibility for an optimal application solution—even in wet areas, and hygienic applications, chemically aggressive environments, and double material detection.



Hygienic Ultrasonic Sensors

All stainless-steel and hermetically sealed design and food-safe materials in accordance with FDA, ECOLAB, and EHEDG: this series is ideal for the food and pharmaceutical industries.

Typical Applications

- Food industry: presence detection and content control of thermoformed trays for food such as meat or vegetables
- Pharmaceutical industry: fill level monitoring in the production and packaging of medical products

Key Benefits

- Fully enclosed, all-stainless-steel sensor AISI 316L (1.4404) resistant to steam-cleaning as well as constant high temperatures up to +85 °C (degree of protection IP68/IP69K)
- EHEDG certification for sensor and bracket ideal for use in product-contact zones
- Gapless design and chemically resistant to aggressive substances and cleaning agents (ECOLAB certified)

Chemically Resistant Ultrasonic Sensors

Maximum material resistance for ultimate availability even in the harshest conditions. These ultrasonic sensors are specially protected against the penetration of aggressive media and can be easily parameterized.

Typical Applications

- Fill level measurement of chemicals like acids or lye
- Presence detection in processes with corrosive vapors, e.g., in tire manufacturing

Key Benefits

- High chemical resistance for maximum durability
- Housing made of high-quality stainless-steel (V2A or V4A) and coated ultrasonic transducer
- IP68/IP69K environmental protection for harsh areas
- Long-range application of up to 6 m

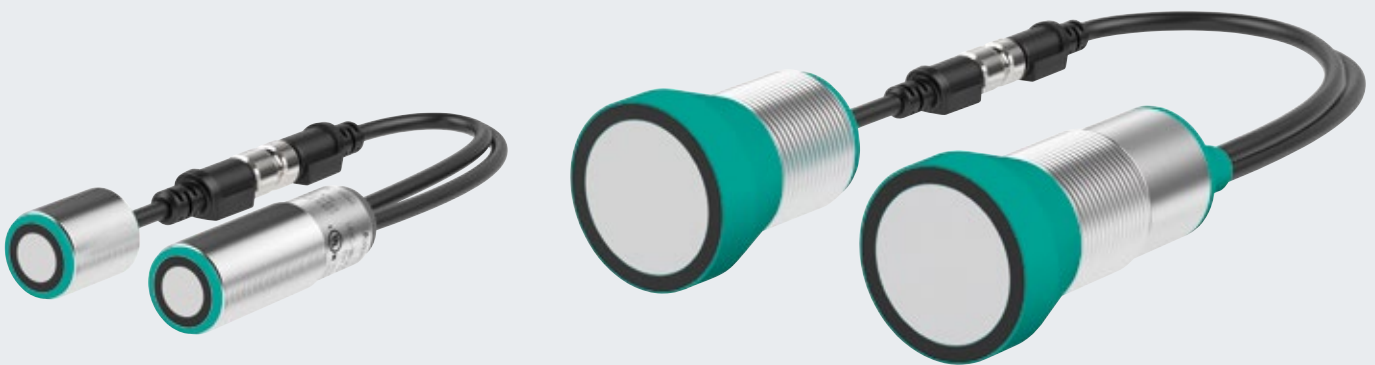

Double Material Detection

Ultrasonic sensors for double material detection help prevent material misfeed and ensure reliable processes. This technology can be used to detect double sheets, labels, and splices.

Typical Applications

- Double sheet detection: on printing machines, in sheet material processing, or when veneering chipboard to prevent the infeed of double sheets or incorrect sheets
- Ultrasonic splice detection: detection of material transition of paper, sheet, or textile rolls
- Label detection: detection and counting in labeling systems

Key Benefits

- Covers a wide range of materials and thicknesses for flexible use
- Extremely short response delay for detection reliability even in applications with high feeding speeds
- Specially adapted splice detection sensors are available for materials with varying densities



**Download the
Ultrasonic Technology Guide**

You will find detailed information on preventing infeed of double sheets or incorrect sheets in particle board manufacturing, how ultrasonic technology works, its advantages, and numerous application examples in the comprehensive Technology Guide from Pepperl+Fuchs.

[www.pepperl-fuchs.com/
fa-technology-guide](http://www.pepperl-fuchs.com/fa-technology-guide)



Ultrasonic Sensor Applications

One Technology—Limitless Versatility

Ultrasonic technology is versatile and reliable. Its wide range of applications is demonstrated by the technology's insensitivity to countless materials, surface types, and colors. Pepperl+Fuchs channels the advantages of ultrasonic technology into high-performance sensor solutions that can handle even the most challenging tasks in any environment.

Adjustable Sound Beam Ensures Fault-Free Performance (1)

Ultrasonic sensors use a sound beam for detection. This provides maximum reliability because detection is performed within a field rather than at a specific point.

If objects cause interference—like steps on the interior wall of a tank—the sound beam can be narrowed. This means that no expensive changes need to be made to the tank. The detection range and performance remain unchanged.

Synchronization for Fault-Free Operation (2)

Mobile lift platforms are monitored by several ultrasonic sensors that are mounted closely together. Sensors mounted in close proximity to each other may cause interference.

To correct this, two types of synchronization are available, depending on the application. When synchronized in multiplex mode, the sensors send signals alternately and analyze their own echo. In common mode, all sensors transmit at the same time and analyze all received echoes. Both scenarios ensure maximum functional reliability.

Hygienic Design: Ideal for the Food and Pharmaceutical Industries (3)

Pepperl+Fuchs also offers solutions that are certified for highly regulated industries such as the food and pharmaceutical industries. Examples include special sensors that ensure reliable detection in product-contact zones in food-packaging facilities—for example, reliable detection while checking the contents of thermoformed trays.

Our ultrasonic portfolio offers hygienic and high-pressure-resistant sensors in stainless-steel, hermetically sealed housing designs, and food-rated materials in-line with EHEDG, ECOLAB, and FDA requirements.

Universal Sensing Technology That Can Handle Any Environment (4)

Ultrasound is a technology that can be used anywhere, offering impressive performance even in tough conditions such as snow, fog, or dust. The ambient temperature can affect the transit time of high-frequency pulses, but Pepperl+Fuchs ultrasonic sensors compensate for this internally. That means the user can always rely on the sensor, regardless of temperature changes.

This is especially useful in outdoor applications—for example, gravel plants, silos, gate systems, and on mobile equipment like hydraulic lifts and garbage trucks.



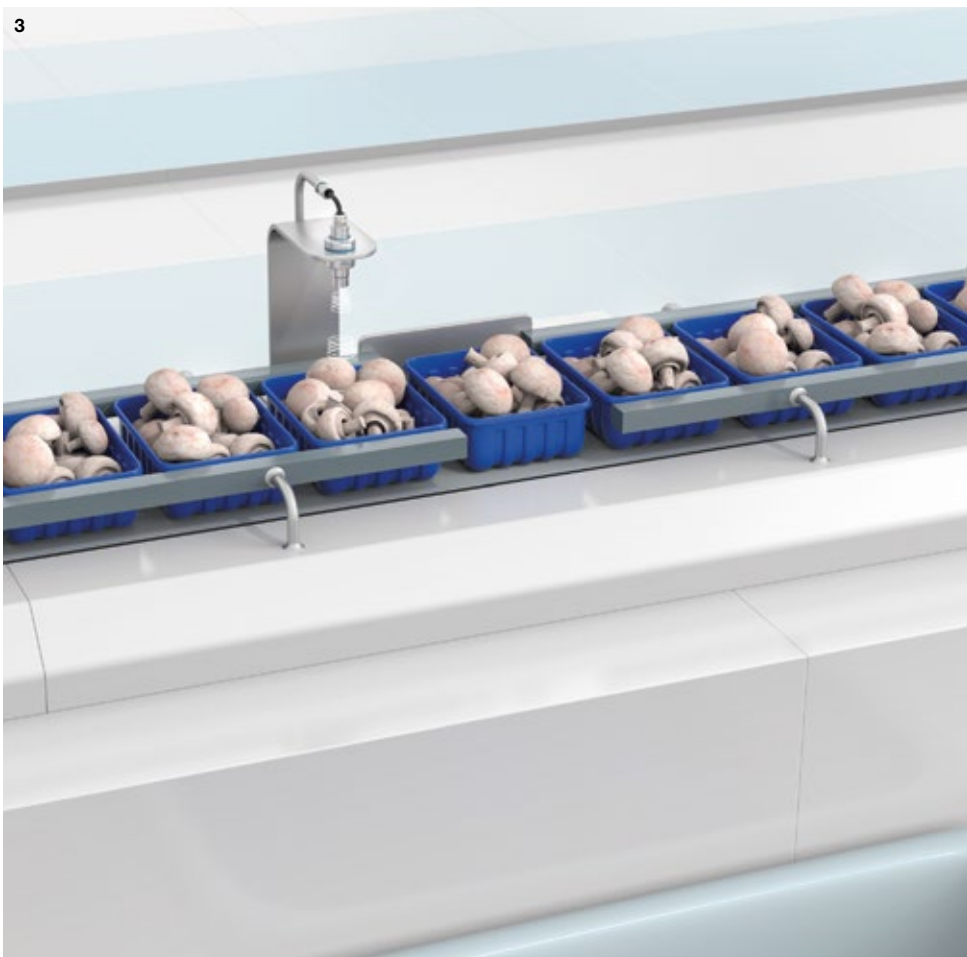
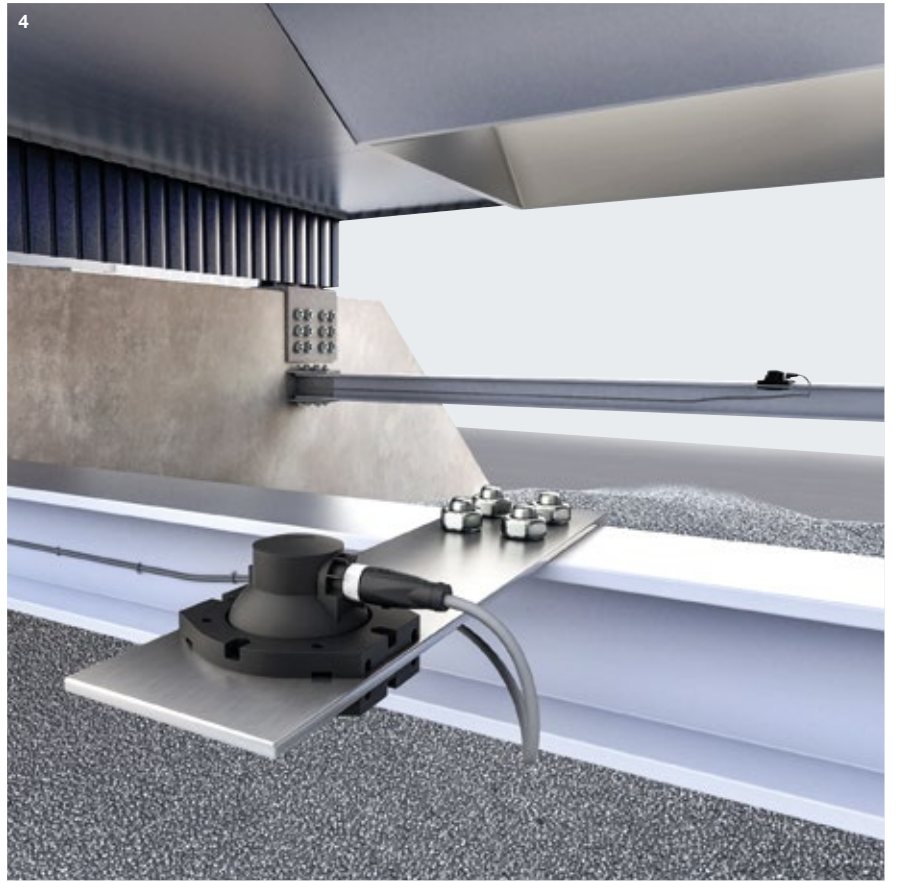

Durable Sensor Solutions for Outdoor Use (5)

We offer ultrasonic sensors that are well suited to extreme operating conditions. Weather-resistant designs can withstand outdoor use, such as on agricultural machinery. One example is controlling the boom height on sprayers.

Sensors used in these kinds of applications are exposed to chemicals from fertilizers and spraying agents. With corrosion-resistant housing designs and IP69K protection, they hold up even in the presence of aggressive chemicals.

IO-Link for Future-Proof Automation and Simple Integration (6)

Ultrasonic sensors with IO-Link interface offer more possibilities for configuration and can be easily integrated into the control environment. They also provide access to valuable process and service data.

This is especially useful for complex processes like those used in the automotive industry. Ultrasonic sensors are used throughout the production process to detect everything from large rolls of sheet metal to doors to complete side panels. Via IO-Link, a variety of parameters can be predefined and easily switched over during the process.

Reliable Processes with Any Material (7)

Wood, metal, or plastic; colored, reflective, or transparent; solid, liquid, or powder—the versatility of ultrasonic technology is almost limitless.

Its insensitivity to countless materials, surface types, and colors makes ultrasonic technology ideal for the packaging industry, where transparent films, colored paper, or reflective labels are processed. Ultrasonic sensors ensure reliable detection and continuous material feed.

Double Material Detection for Continuous Processes (8)

An accidental, multilayer feed of materials such as paper, plastic, metal, film, or labels can cause machine downtime, process faults, and waste. Ultrasonic sensors for double material detection help prevent misfeeds and ensure reliable processes and maximum uptime.

Double sheet sensors are used to monitor material feed during the processing of particle board and plastic sheets. They work with a wide range of materials and can be adapted to various material strengths and process speeds. This prevents machine downtime and material waste.



6

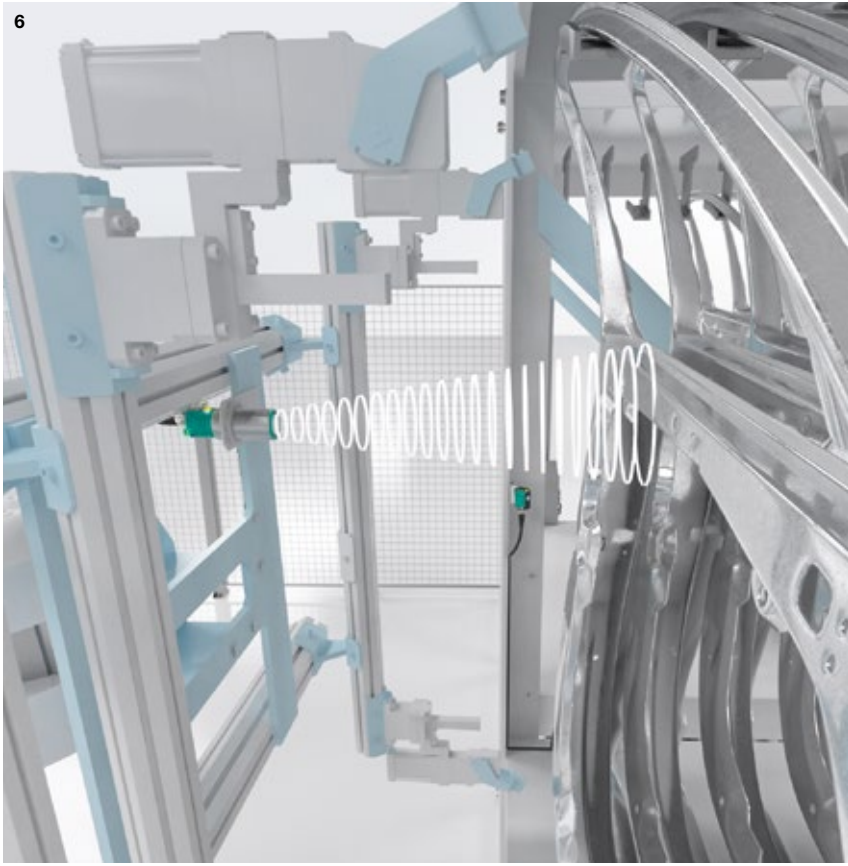

8

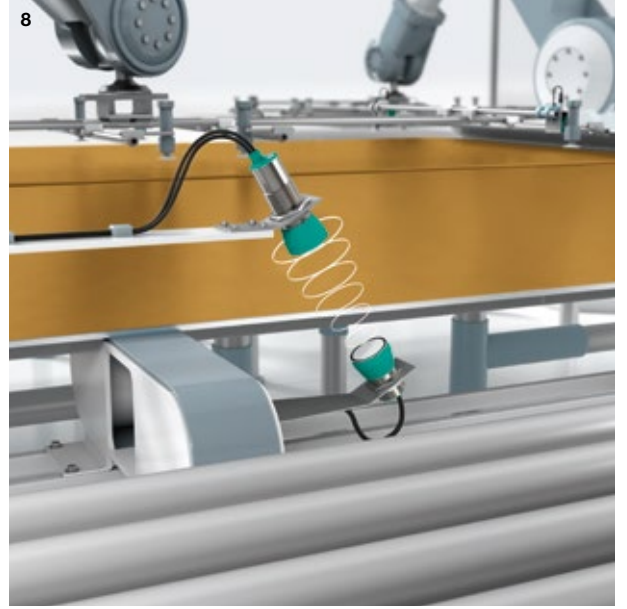

7



Identification Systems

Versatile Technologies for Maximum Transparency

Identification systems ensure reliable, transparent processes. Depending on your application requirements, you can choose from a range of optical and radio-based systems from Pepperl+Fuchs and benefit from the unique advantages of both technologies. Working hand in hand with our experts, you will always find the optimal identification solution.

RFID—a Flexible System Solution That Delivers Complete Transparency

For applications that require flexibility, Radio Frequency Identification (RFID) is the perfect choice. Radio-based technology makes it possible not only to read object information but also to modify it as required—all without the need for visual contact between the reader and tag.

Pepperl+Fuchs gives you a complete system solution of perfectly harmonized components, covering all frequency ranges. Established application expertise and a broad portfolio of control interfaces, read/write heads, and tags in LF, HF, and UHF ensure the optimal solution for every identification task.

Optical Identification—an Economical Solution for Track-and-Trace Applications

If cost is the top concern, optical identification solutions are the right choice. Printed codes and direct part marking (DPM) offer a lower-cost solution.

Pepperl+Fuchs' optical identification systems ensure high read performance and outstanding reliability even in challenging conditions. Whether for stationary standstill or high-speed reading, mobile identification, or high-temperature applications—our high-performance devices deliver maximum transparency.



For more information, visit
www.pepperl-fuchs.com/fa-ident





RFID Control Interfaces

IDENTControl: Flexibility and Compatibility

Easy to integrate into the system environment, RFID control interfaces provide complete flexibility. IDENTControl system devices are compatible with all frequency ranges and deliver absolute reliability.



Key Benefits

- IDENTControl—maximum flexibility by combining different RFID frequencies on the same device
- Absolute noise immunity with EMC protection and a robust, fully encapsulated metal housing
- Simple system integration with connectivity to all fieldbus types
- Compact models available—ideal for decentralized installations
- Easy commissioning with graphical display and configuration buttons
- Pluggable connections for easy operation

Technical Features

- Connection of up to four read/write heads at the same time
- Alternatively, two read/write heads and two trigger sensors can be connected
- Bus connection via Ethernet-based protocols such as EtherNet/IP, PROFINET, EtherCAT, TCP/IP, MODBUS TCP, and DeviceNet as well as CC-Link, PROFIBUS, and serial
- LED status indicator for bus communication and read/write heads
- IP67 protection



IDENTControl System

Pepperl+Fuchs' IDENTControl system offers clear advantages. Read/write heads of different RFID frequencies (LF, HF, UHF) can be combined in a single unit, and preconfigured modules enable simple and quick system integration. This increases flexibility when designing and expanding systems.

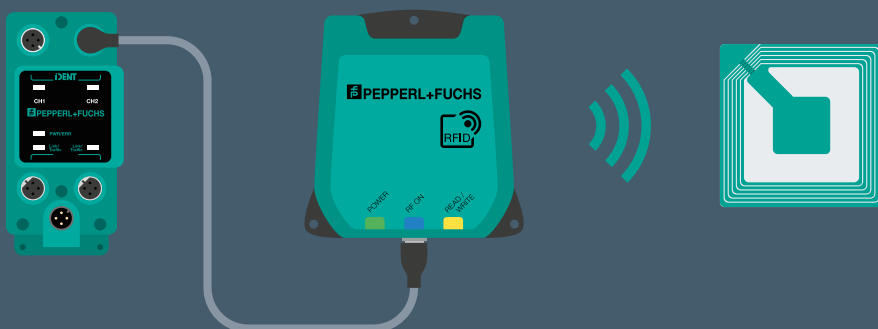

RFID Read/Write Heads

A Variety of Products in All Frequency Ranges

The combination of LF, HF, and UHF read/write heads in a wide variety of housing designs provides maximum performance in any application. Whether in logistics, workpiece carrier manufacturing, or skid identification—based on the application requirements, you can choose from a portfolio of models in all frequency ranges and benefit from their individual advantages.

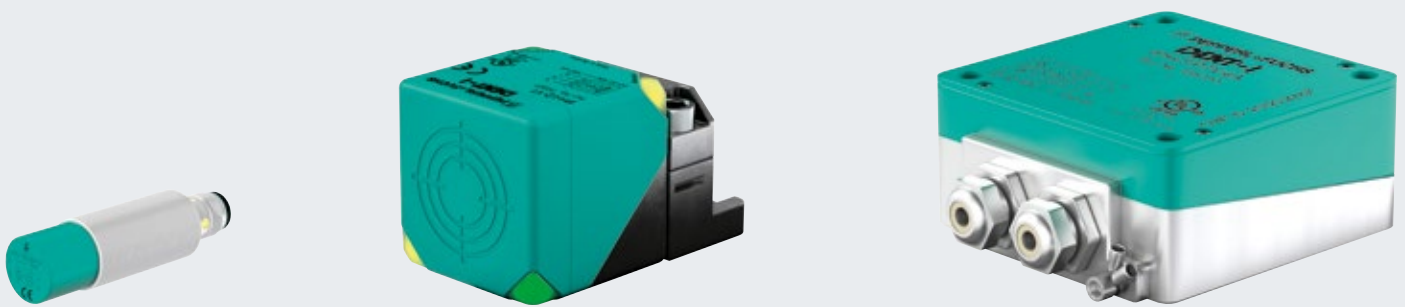

LF and HF Read/Write Heads

For near-field applications in a range of a few centimeters, LF and HF read/write heads ensure uninterrupted system operation. LF systems are usually used in metallic environments such as conveyor systems. HF systems are well suited to applications where large quantities of data are transmitted at high speed, such as pallet identification in logistics processes.

Typical Applications

- Machine and plant engineering—tool or workpiece carrier detection, counterfeit protection, or machine access
- Storage and conveyor technology—tray or pallet identification in roller conveyor systems, object identification on overhead monorails
- Food and beverage industry—food traceability, tooling protection
- Mobile equipment: driver identification, detection of accessory equipment

Key Benefits

- Wide range of cube-style and cylindrical housing styles in LF and HF frequency ranges
- Compact housings enable installation in space-restricted settings or flush mounting in metal
- Special designs optimized for integration into roller conveyor systems
- Stand-alone version with RS-485 protocol
- Devices are also available for use in demanding applications, such as food and beverage or in hazardous areas

Technical Features

- Frequencies: LF (125 kHz), HF (13.56 MHz)
- Read distances up to 135 mm
- Stainless-steel and explosion-proof models available
- Read/write heads with protection up to IP68/IP69K and NEMA Types 4, 7, and 9



UHF Read/Write Heads

UHF read/write heads are ideal for applications that cover a wide area with read ranges of up to 6 m. The innovative design with integrated antenna results in a compact device that can be used almost anywhere. And adjustable polarization ensures maximum flexibility and reliability.

Typical Applications

- Automotive industry—tag/label identification in car body processing, on the paint line, and during final assembly
- Storage and conveyor technology—product-specific identification in batches and process-specific identification of individual crates, boxes, etc.
- Vehicle identification on access roads, personnel access at workstations

Key Benefits

- Flexible UHF read/write heads for medium and large ranges and global use
- Preconfigured modules enable quick and easy system integration
- Compact and rugged housing for versatile use
- Switchable antenna polarization ensures reliable tag identification and dependable operation
- Multitag reading with up to 200 tags for increased productivity

Technical Features

- Linear-vertical and linear-horizontal polarization including automatic switching
- Adjustable read range for smooth operation
- Selection of frequencies for global use
- Read ranges up to 6 m

RFID Handhelds

Efficient and Flexible

In addition to stationary RFID devices, Pepperl+Fuchs also offers RFID handhelds for mobile identification. Available in all frequency ranges (LF, HF, and UHF), they enable efficient and flexible data logging. Customizable software enables optimal integration into your processes.



Handhelds

Our RFID handhelds are the ideal mobile solution for identifying and editing RFID tags. Handhelds in LF, HF, and UHF are available for every requirement.

Key Benefits

- Maximum flexibility with software customization to fit the identification task
- A function module integrated into the standard software enables direct connection to the control panel
- Easy operation with a large touch display and keyboard—also suitable for operation with work gloves
- Rugged design for indoor and outdoor use
- High productivity with fast and reliable identification
- Variety of helpful functions are available in the standard software—e.g., writing of multiple tags using a batch file

Typical Applications

- Manual quality control and verification of testing and maintenance
- Warehouse management, picking, and inventory
- Identification of tool inserts, pallets, or trays
- Access control, identification of clothing and other goods

Technical Features

- LAN, WLAN, and Bluetooth available
- Optional 2-D imager
- Customizable quick-entry keyboard
- 3.5" TFT color display with LED backlight for easy readability, even in low light conditions
- Windows Embedded CE 6.0
- Comprehensive accessories, including charging and docking stations, rechargeable batteries, and pistol grip

RFID Tags

Maximum Variety Suitable for Any Environment

Data availability at any time requires robust and versatile tags that work reliably under all circumstances. Pepperl+Fuchs offers the right tags for each application in the frequency ranges LF, HF, and UHF.



Tags in LF, HF, and UHF

Pepperl+Fuchs has a broad portfolio of RFID tags that are optimized for industrial use, including low-cost and ruggedized versions. Our application experts can help you select the best combination of tag and read/write head for your application and build the perfect RFID system solution.

Key Benefits

- Expert consultation to help you choose the best RFID tag for your application
- Comprehensive portfolio of tags in LF, HF, and UHF
- Range of designs, including small tags that can be mounted in metal and ruggedized versions with thermal or chemical resistance

Technical Features

- Models for special mounting conditions, i.e., in metal or for high-temperature applications
- Environmental protection up to IP68/IP69K
- Available in cylindrical, cube-style, and special housing designs and as access cards

RFID Applications

Individualized Production in the Automotive Industry

Fault-free processes, dependable quality, and individualized production—the demands on modern automotive production are enormous and increasing steadily. RFID enables absolute transparency and ensures maximum flexibility.

Low-Quantity Production

The automotive industry has been a pioneer in highly individualized production processes. Depending on the order, specific customer requirements, such as paint color or special options, can be implemented in partially automated processes. This is all made possible through continual identification and assignment of workpieces. RFID is often used in order to maintain the highest level of flexibility.

Precise Identification on Skids and Monorail Conveyors (1)

There are countless applications for RFID in automotive production. Tags are usually integrated into skids or monorail conveyor systems, on which car bodies are transported from one station to the next. Depending on the application, LF or HF read/write heads are mounted at the stations to identify the vehicle from a short distance and trigger the appropriate production step.

Long-Distance Bulk Reading with UHF (2)

UHF is used in applications where tags have to be detected over long distances or where several tags have to be detected at once. With the F192 UHF read/write head, for example, up to 200 tags can be handled simultaneously and from a distance of up to 6 m. A typical application is in the final assembly, when multiple body assemblies are verified at the same time.

The Key to Industry 4.0

Sensorik



Unlike other technologies, RFID makes it possible for data to be both read and written. This allows completed and upcoming production steps to be stored on the tag and sent along to the next stages of production.

Attached directly to the workpiece, RFID technology allows the production process to be controlled virtually independently. By enabling flexible production, networked to systems that are located beyond the physical walls of the plant, RFID is a prerequisite for the fourth industrial revolution—Industry 4.0.

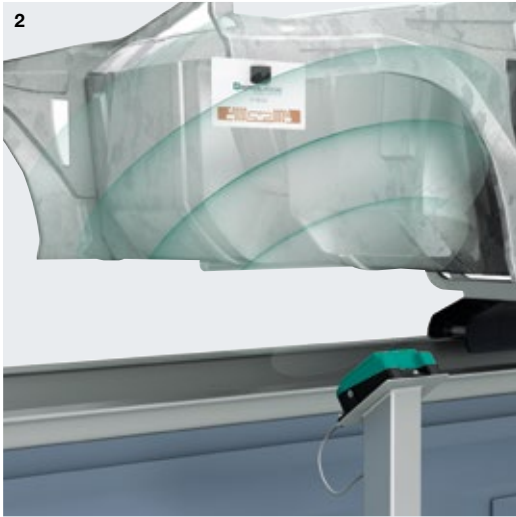
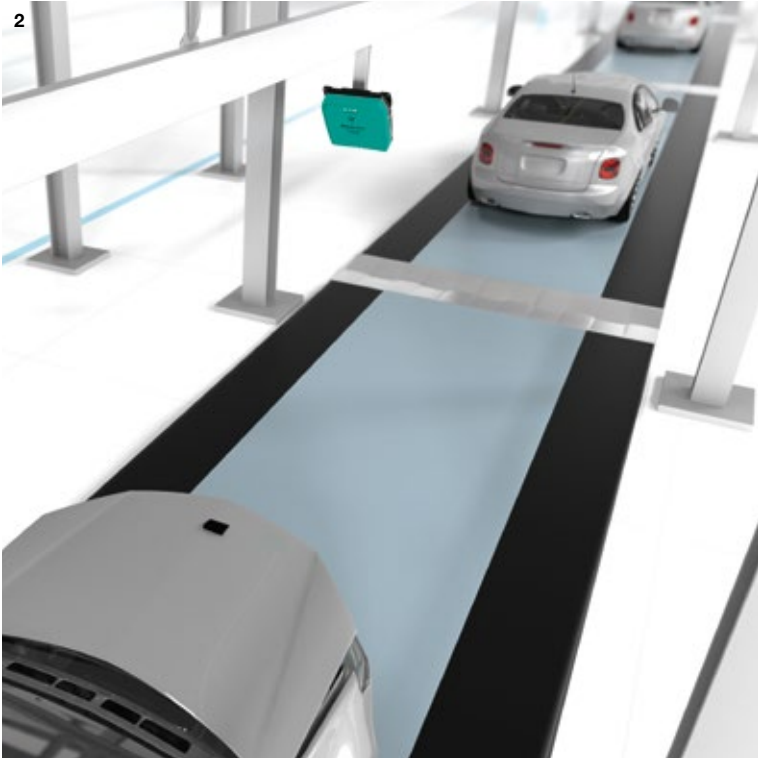

For more information, visit www.pepperl-fuchs.com/fa-automotive



Stationary Optical Code Readers

High-Performance at Standstill and High Speeds

Whether at standstill or in motion with codes that are printed or directly marked—Pepperl+Fuchs' stationary readers meet all the requirements of cost-efficient identification solutions. They provide simple, intuitive operation and powerful functionality.

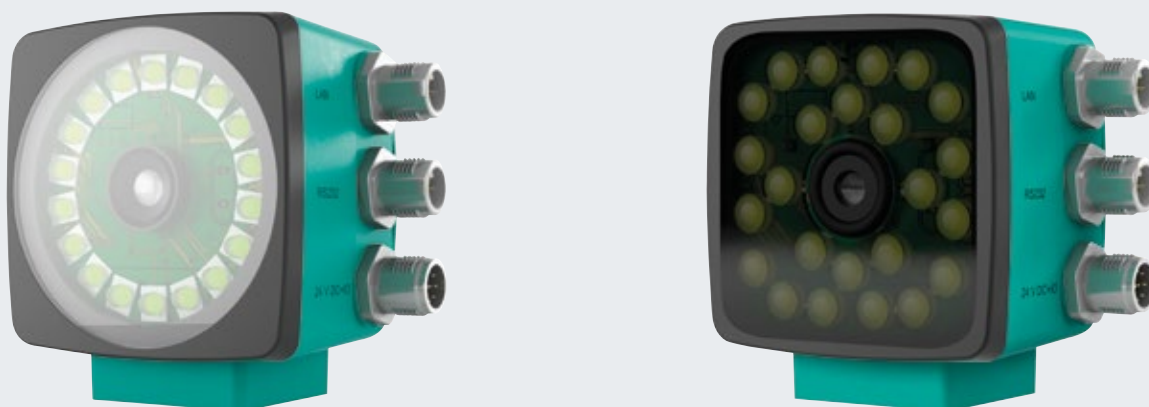

Camera-Based Code Readers

Camera-based code readers are easy to operate and offer versatility with a breadth of functions. Higher-performance models deliver reliable readings even in extreme conditions. Fast code reading, reading on highly reflective surfaces, and user-friendly operation software add to the benefits.

Typical Applications

- Print and paper industry: print presence detection, logo comparison, and code reading in enveloping machines
- Automotive industry: track-and-trace applications for parts, even with direct markings
- Semiconductor industry: controlling SMD placement
- Storage and conveyor technology: code reading on boxes and trays

Key Benefits

- Reliable 1-D/2-D code reading, even on reflective surfaces, such as foil, plastic, or metal
- High-speed code reading up to 10 m/s at 100 readings/s
- Large depth of focus for code reading with different distances and sizes using one setting
- Easy operation and configuration with intuitive Vision Configurator software
- Automatic storage of error images for quick and easy troubleshooting

Technical Features

- All common code symbologies, including DPM codes, are readable
- Powerful functions such as print presence detection, logo comparison, and multiwindow mode, which allows simultaneous use of all functions on up to four reading fields
- Interfaces such as Ethernet TCP/IP, RS-232, and I/Os for simple system integration



Barcode Scanners

Varying code sizes, long distances, damaged codes, and high speeds: when it comes to barcode systems, every application has its own unique requirements. Pepperl+Fuchs offers four series of barcode scanners to cover even the most difficult applications, such as low temperature applications.

Typical Applications

- Storage and conveyor technology: code reading on boxes, pallets, and trays
- Print and paper industry: code reading in enveloping machines
- Packaging industry: verification and organization of products for packaging
- Automotive industry: reading Odette labels

Key Benefits

- Optimized portfolio with compact housing designs for space-restricted installations, such as packaging machines
- High scan rates of up to 1,200 scans/s for extreme process speeds
- Automatic and programmable focus for continuous processes
- Reliable code reconstruction for reading damaged or skewed barcodes
- Wide application range with an expanded temperature range down to -35°C

Technical Features

- Large read ranges of up to 2,000 mm
- High scan rates of up to 1,200 scans/s
- Reading small codes down to 0.15 mm
- Networking of up to 32 scanners in an integrated, comprehensive solution
- Rugged aluminum housing designs available

Optical Handheld Readers

The Perfect Addition for Mobile Identification

Outstanding read quality, easy to use, and perfectly adapted to your application. Mobile handheld readers from Pepperl+Fuchs exceed these requirements and offer absolute ease of use. They can be connected to a PC or tablet for maximum mobility.



Typical Applications

Mobile identification applications in industries such as machine building, automotive, packaging, and warehouse technology:

- Warehouse management, data collection in ERP systems, inventory applications
- Identification at workstations
- For reading DPM codes, including lasered and nailed codes, i.e., on motor blocks and PCBs

Key Benefits

- Wired devices for reading big 1-D, small 2-D, and DPM codes at the same time
- Wireless devices with integrated memory and Bluetooth for automatic data transfer to a PC
- Models with display and keyboard available for easy operation and display of results
- Intuitive Vision Configurator software enables simple and flexible integration into ERP systems via output-string customization
- PC and tablet connection for maximum mobility

Technical Features

- Easy adaptation to different code sizes with patented dual lens and 1.2-megapixel resolution
- Customization and programming directly on the handheld via control codes, configuration software, and JavaScript
- Durable housing design with IP65 protection for challenging environments
- Extensive accessories for flexible application, e.g., brackets for stationary use with automatic motion detection, charging trays with Bluetooth modems, and gateways for PROFINET connection

Optical High-Temperature Identification

Extreme Performance in Tough Conditions

Cyclic temperature change, constant elevated heat, and the effects of dust or paint place tough demands on materials and technologies. The rugged OIT high-temperature identification system withstands these challenges. Even at temperatures up to 500 °C, the system ensures reliable readings and smooth operation.



Typical Applications

- Automotive industry: identification during shell construction, painting, galvanizing, and drying
- Identification in facilities that process paint and varnish
- Identification of baking sheets in bakeries

Key Benefits

- Durable solution with heat-resistant code sheets for temperatures up to 500 °C
- Reliable identification, even with damaged code sheets
- Integrated diagnostics for reliable operation
- Maintenance-free due to a one-piece housing design without additional components
- Simple connection to all standard controllers

Technical Features

- Identification of up to one million objects via robust code sheets
- Simple system integration via Ethernet interface
- Large read ranges up to 1,700 mm
- Tough, powder-coated aluminum, die-cast housing

Optical Identification Applications

Ensuring Transparency—Even in Extreme Conditions

From deep-freeze storage to industrial ovens—optical identification systems from Pepperl+Fuchs offer complete reliability in the most extreme locations.



Reading Barcodes at Low Temperatures

In the food industry, an uninterrupted cold chain is essential for product quality. But this places high demands on sensor technology. In order to ensure efficient and reliable automation, even in deep freezers, special devices such as the VB14N-T barcode scanner are used.

With an integrated heater, this scanner can withstand ambient temperatures of -35 °C to $+45\text{ °C}$. It also offers a short warm-up time and reduced energy consumption of 9.6 W.

High Performance at High Temperatures

Production conditions in drying plants, paint lines, galvanic plants, and bakeries involve extreme heat and contamination. Cyclic temperature changes, continuous heat, and the effects of dust or varnish push materials and technology to their limits.

Designed to withstand these extreme conditions, the rugged OIT high-temperature identification system from Pepperl+Fuchs ensures smooth processes under the toughest conditions. Reliable performance is ensured even at temperatures up to 500 °C .



The Right Codes for Every Application

For identification in extreme conditions, the performance of code scanners depends on the quality of the code. Standard paper labels cannot be used at temperatures reaching 500 °C. For such temperatures, durable, punched metal code sheets are used. Direct part marking (DPM), in which parts are permanently marked with product information, is used in other applications.

To help you find the best solution—even for the harshest applications—our optical identification portfolio includes a variety of codes and code readers.

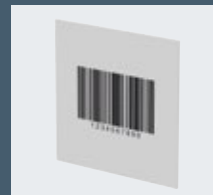

Barcode and Data Matrix codes on paper labels, laser-marked code (DPM), and metal code sheet

Industrial Vision

Sensor and System Solutions from a Single Source

Sheet verification, profile comparison, area monitoring, and high-precision measurement. These are just some of the applications that are suited to industrial vision technology. Pepperl+Fuchs offers everything needed for advanced vision solutions—from easy-to-integrate vision sensors to complete, high-performance systems.

Light Section Sensors from Pepperl+Fuchs

Light section technology is based on the triangulation principle and is used to detect and measure surface profiles. Pepperl+Fuchs offers light section sensors for profile recognition, profile comparison, and high-precision monitoring.

Vision Sensors from Pepperl+Fuchs

Vision sensors are designed for simple installation and operation and can be easily integrated into new and existing systems. Digital outputs and teach-in functions allow commissioning and operation of sensors without additional programming or software.

Vision Systems from VMT

VMT Vision Machine Technic Bildverarbeitungssysteme GmbH, a subsidiary of Pepperl+Fuchs, supplies turnkey and customized industrial vision and laser sensor systems for all industrial sectors. As the competence center for vision solutions in the Pepperl+Fuchs Group, VMT offers absolute high-level technology combined with maximum security of investment.



For more information, visit
www.pepperl-fuchs.com/fa-vision





Industrial Vision

Advanced Technology Made Easy

Our goal is to make image analysis systems as easy to use as sensors. Vision sensors with digital outputs and simple parameterization make using these complex technologies easier than ever before.



Light Section Sensors with SmartRunner Technology

Based on an innovative combination of light section technology and 2-D vision, SmartRunner is a family of high-precision sensors tailored to the needs of specific applications. These innovative sensors transform complex profile data into easy-to-process digital signals, making integration into the overall process incredibly simple.

Key Benefits

- Unique combination of light section technology and 2-D vision sensor with integrated LEDs opens up a variety of new applications
- Application-specific sensors—preconfigured and calibrated based on the application
- Transformation of complex measurement data into simple digital signals for fast and easy integration
- Easy installation due to parameterization via Data Matrix control codes or teach-in

Typical Applications

SmartRunner Matcher—the Specialist for Profile Comparison:

- Verification of one or more parts for presence and completeness
- Quality control in packaging processes
- Verifying position and correctness of objects

SmartRunner Detector—the Specialist for High-Precision Monitoring:

- Protecting sensitive machine parts
- Detecting product overhang
- Overhang detection even at standstill



Vision Sensors for Sheet Verification

Sheet verification sensors from Pepperl+Fuchs make it possible to quickly and easily verify the correctness of sheets in collating, folding, and binding machines. For the first time, the BIS510 combines the benefits of image and code matching in one sensor, saving costs and maximizing flexibility.

Key Benefits

- Automatic teach-in of reference sheet enhances ease of use and reduces changeover times
- Image and code matching in one sensor simplifies installation and saves costs
- High reading speed up to 4 m/s with a maximum of 10 sheets/s
- Innovative polarization filter technology ensures reliable detection, even on reflective surfaces

Typical Applications

- Sheet verification in collating, folding, and binding machines

Additional Application-Specific Vision Sensors

Industrial vision is used in a wide variety of areas. In addition to the sensors described above, application-specific products can also be found in the chapters on identification (page 44) and positioning systems (page 66).

Industrial Vision Applications

Light Section Sensors with SmartRunner Technology

Our application-specific SmartRunner sensors offer the advantages of complex light-section systems with the easy operation of a standard sensor. With plug-and-play installation, they intelligently evaluate height profiles and convert them into easy-to-process digital signals.

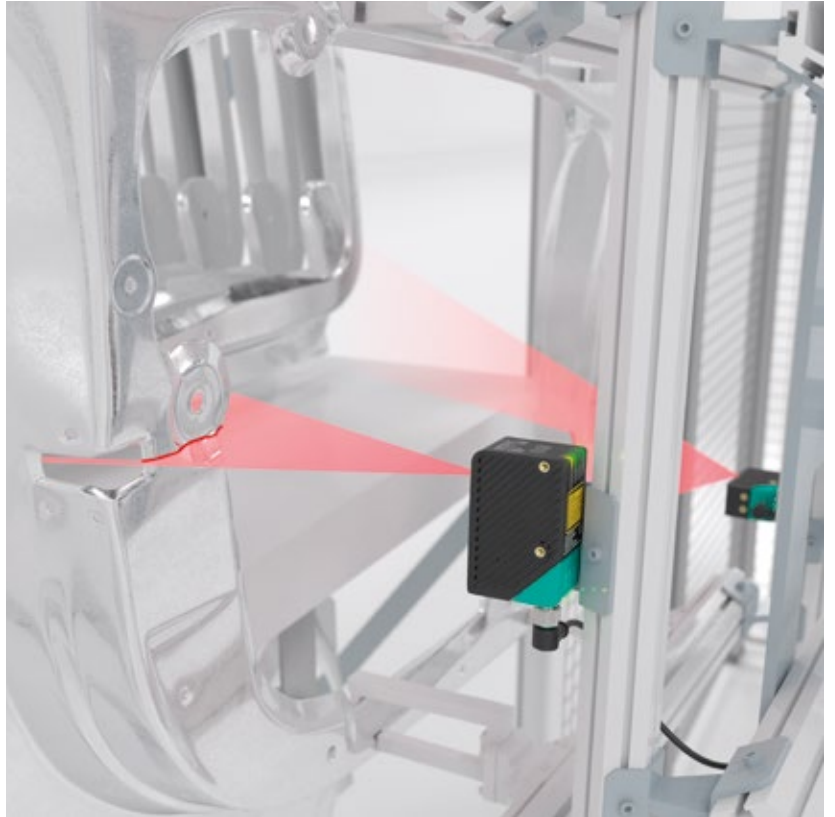
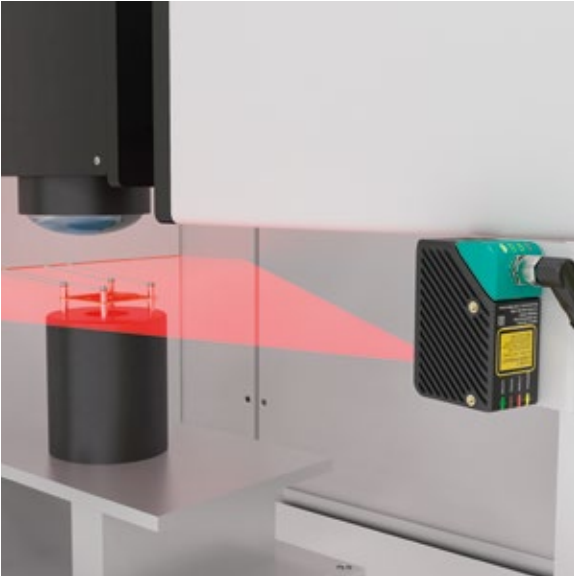

SmartRunner Detector—the Specialist for High-Precision Monitoring

The SmartRunner Detector monitors sensitive machine areas by detecting product overhang and shutting down the machine if necessary. It increases machine uptime and helps avoid expensive repairs and part replacement. With high precision light section technology, the sensor detects any deviation from the previously taught-in background. In a trapezoidal detection range the sensor can detect objects as small as 1 mm. A “bad” signal on the digital output clearly indicates a bad part or obstruction.

SmartRunner Matcher—the Specialist for Profile Comparisons

The integrated processor of the SmartRunner Matcher is programmed in the factory to report deviations from a taught-in contour. Via profile comparison, the sensor verifies the recorded contour of an object, its correct location, and spacing. In the event of a fault, collision and damage are avoided and lengthy machine time is reduced. To do this, a specific height profile is programmed and a trigger executes a comparison between the reference and recorded contours. If these are identical, a “good” signal is sent. If the two profiles are different, a “bad” signal is given.

High-Precision 3-D Light Section Systems from VMT

As a subsidiary of Pepperl+Fuchs, VMT Vision Machine Technic Bildverarbeitungssysteme GmbH provides innovative solutions like the one-of-a-kind SpinScan 3D light section system. With an additional axis of rotation, this multi-sensor system makes it possible to accurately measure 3-D surfaces without shadowing effects.

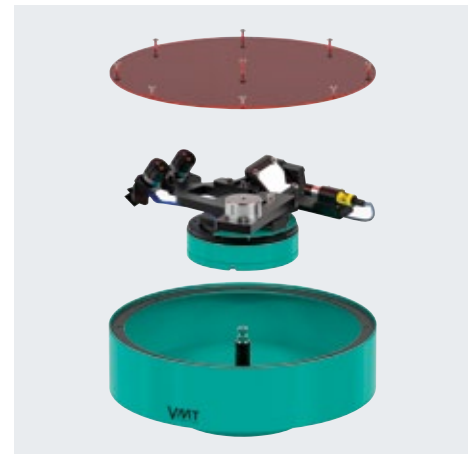
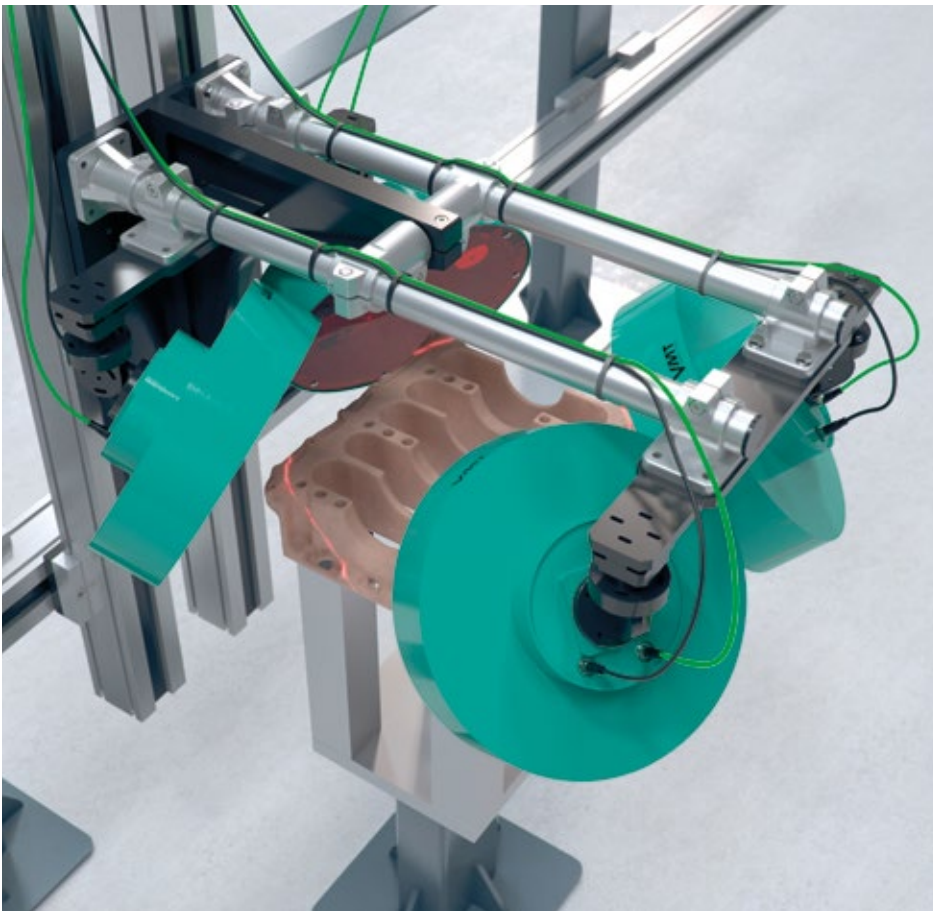

Sand Core Inspection for Increased Efficiency

SpinScan 3D was developed to provide precise measurements of 3-D surfaces without shadowing. This allows users to match specified and actual shapes and fully automate quality control.

One common application for this system is automotive production. For example, sand cores used to cast engine blocks are measured and quality tested before production. SpinScan 3D records the exact form of the core and verifies it against the specified dimensions from the CAD construction. This allows deviations to be detected and corrected before the expensive and time-consuming casting process begins—reducing costs and preventing faulty castings.

VMT Vision Machine
Technic Bildverarbeitungs-
systeme GmbH



VMT® supplies turnkey image processing, laser sensor systems, and customized vision solutions for all industrial sectors. VMT solutions are based on our own self-developed product lines, which cover the entire spectrum of applications. As the competence center for vision solutions in the Pepperl+Fuchs Group, VMT offers advanced technology combined with the highest investment security.



For more information, visit
www.vmt-vision-technology.com

Positioning Systems

Advanced Technologies for Precise Position Detection

Pepperl+Fuchs uses a range of technologies to provide industrial positioning systems for virtually any positioning task. Whether precision, process reliability, or cost is your top priority, our unique product selection makes all the benefits of optical, camera-based, and inductive systems available in one portfolio.

Perfected over 25 Years and Counting

With the introduction of the world's first absolute positioning system in 1989, a success story began that has continued to this day. Constantly evolving and adapting to solve new customer scenarios, the portfolio consists of solutions that have been tried and tested in countless applications.

Versatile Technologies for a Variety of Applications

Whenever production goods or moving machine parts need to be safely and efficiently transported or precisely positioned, customers benefit from our unmatched technological expertise. Depending on the application, inductive, optical, or camera-based systems are available. Even for harsh outdoor use, in dusty environments, or over long distances—Pepperl+Fuchs' portfolio has a solution for your positioning task.



For more information, visit
www.pepperl-fuchs.com/fa-positioning



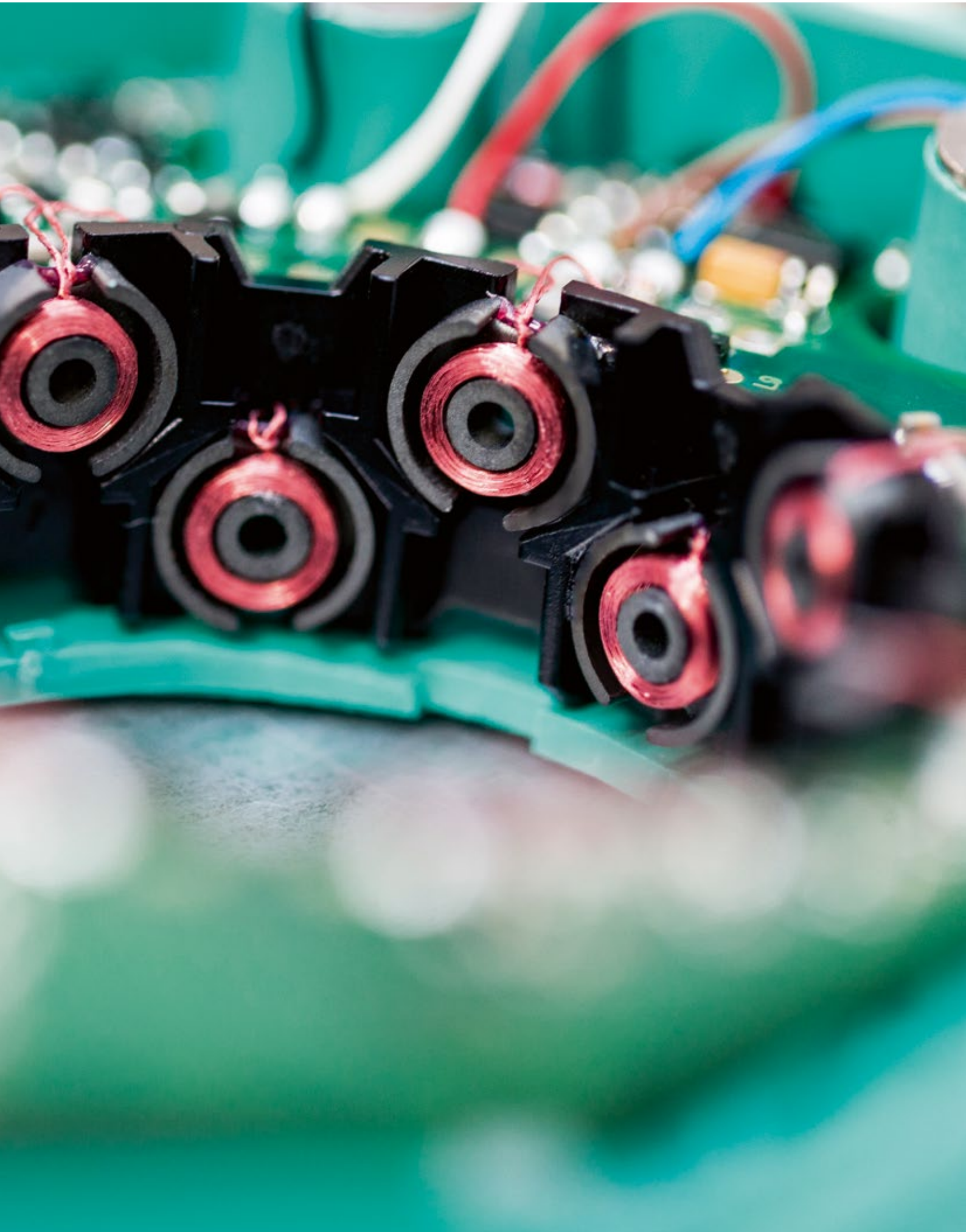

Optical Positioning Systems

Reliable Even over Long Distances

For standard and special applications, our optical positioning systems offer maximum reliability: the WCS absolute positioning system for harsh outdoor conditions, the PCV Data Matrix positioning system for uncompromising reliability, Position Guided Vision (PGV) for automated guided vehicles, and the PHA for precision positioning.



WCS—Positioning in Harsh Environments since 1989

This system is based on the combination of a metal or plastic code rail with photoelectric sensors and ensures precise positioning, even in the most challenging environments.

Typical Applications

- Storage and conveyor systems in harsh conditions
- Galvanizing plants
- Elevator technology

Key Benefits

- Maximum ruggedness with tough, dirt-resistant code rail and powerful LED transmitters
- Absolute reliability thanks to over 25 years of application experience and continuous improvement

Technical Features

- Compatible with most industrial protocols
- Code rail length up to 327 m (modular and extendable)
- Suitable for curves, lane changes, dips, and gradients
- Rugged design for outdoor use

PCV—Redundancy Increases Reliability

The unique combination of a 2-D camera system with multi-redundant Data Matrix code tape allows precise position detection and uncompromising reliability.

Typical Applications

- Positioning of skid and monorail conveyors
- Lifting and elevator systems

Key Benefits

- Insensitive to dirt and code-tape damage due to code redundancy and a wide read window
- Quick commissioning via parameterization with Data Matrix control codes, PC, or directly through the control system

Technical Features

- Self-adhesive code tape and measurement range up to 10,000 m
- Comprehensive diagnostics
- Positioning along two axes



PGV—Future-Proof Navigation

Colored strips show the route, Data Matrix codes give position feedback, and control codes are used to navigate. Position Guided Vision (PGV) is the ideal solution for automated guided vehicles (AGVs).

Key Benefits

- Flexible navigation via colored route-tracking tape/paint, Data Matrix code tape, Data Matrix tags, or a combination of all
- Reliably detects different routes, even on highly reflective surfaces, with damaged tape, or in dirty environments

Technical Features

- Works with any type of route strip of varying color and width
- Compatible with most industrial protocols

PHA—Cost-Effective Precision Positioning

Designed specifically for precision positioning in high-bay warehouses, the PHA detects existing holes in the rack structure and determines their position deviation from a target location. Common disruptions such as dirt, extraneous light, or material wear are no problem.

Key Benefits

- Maximum reliability regardless of warehouse lighting or environment
- Efficient storage utilization thanks to high-precision monitoring
- Less raw materials needed due to reliable positioning, even with material wear or distortion

Technical Features

- Range of 150 to 950 mm with a large detection range
- Can be used in cold storage at temperatures down to -30°C

Inductive Positioning Systems

Perfection for Demanding Applications

Perfect linear position detection and angular measurement—reliable even in dusty and dirty applications or with temperature fluctuations. The inductive position measuring system (PMI) offers an ideal solution for any industrial positioning application.



Typical Applications

The PMI is available for both linear and angular measurement. With inductive technology, no special target is needed—only a simple, steel actuating element. The result is an unlimited range of applications. Typical examples include:

- Mobile equipment: steering wheel positioning, position detection of crane booms
- Positioning of metal parts in machine building
- Print and paper industry: dancer control in roller-feed printing presses, rotation detection in pile turners
- Controlling packaging or filling cycles

Key Benefits

- Noncontact, maintenance-free, and contamination-resistant for maximum durability
- Wide range of functionalities with configurable measurement and switch functions
- Simple steel actuating element opens up a variety of applications—use your own or order as an accessory
- Variety of models ranging from small housings (14 mm) for machine tools to large housings (960 mm) for heavy machinery
- Interference immunity ensures reliability
- Cost-effective—measurement and switching functions combined in one device

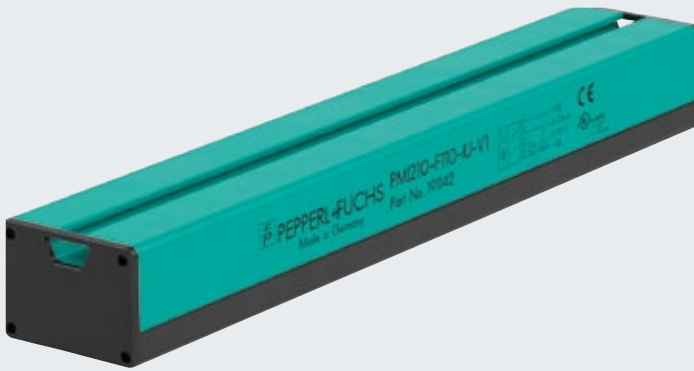

Technical Features

- Wide range of functions with programmable measurement and switching range
- IO-Link models for customer-specific parameterization
- Models available for linear or angular measurement
- Position detection from 0 to 2.5 mm and 0 to 6 mm, independent of distance
- Fully encapsulated sensors with up to IP67 rating for outdoor applications

Positioning System Applications

Position Guided Vision for Automated Guided Vehicles

Colored paths for route-tracking, Data Matrix codes for positioning, and control codes for navigation—this unique combination in one device makes the PGV positioning system the optimal solution for controlling automated guided vehicles (AGVs).

Unique Combination for Maximum Flexibility

Position Guided Vision (PGV) is the world's first and only Data Matrix positioning system that combines route tracking via colored navigation stripes and accurate positioning via Data Matrix codes in one device. This revolutionary combination ensures precise, reliable, and efficient production processes. Users are given the flexibility to handle increasingly complex industry requirements.

Precision and Dependability for Smooth Production

The PGV positioning system features an advanced camera with integrated illumination and powerful signal processing. As an AGV moves along a colored or coded path, the exact position is determined. Path deviations are automatically corrected using X and Y position and angle outputs. With Data Matrix code tape, the PGV can also control the AGV's speed. This helps transport goods safely and efficiently.

Exact Positioning and Reliable Navigation

The PGV uses Data Matrix codes for various functions. Turns in the AGV's route can be initiated with Data Matrix control codes. Exact positioning of the AGV is easy with Data Matrix code tape. Navigation via tag mode is also available: the AGV receives navigation information exclusively from Data Matrix codes, which are attached to the ground in a fixed pattern.

The PGV's wide scan window allows navigation on tight curves or damaged paths. This ensures reliable control of AGVs at all times.



Key Benefits

- Reliably detects different colored route-tracking tape/paint and Data Matrix codes, even on highly reflective surfaces
- Excellent extraneous light immunity, >100,000 lux, eliminating the need for additional contrast tape
- Wide scan window coupled with 2-D Data Matrix technology provides seamless navigation over damaged or dirty tape
- Compact housing fits in the smallest AGVs
- Easy mounting and installation with plug-and-play connectivity
- Compatible with most industrial protocols

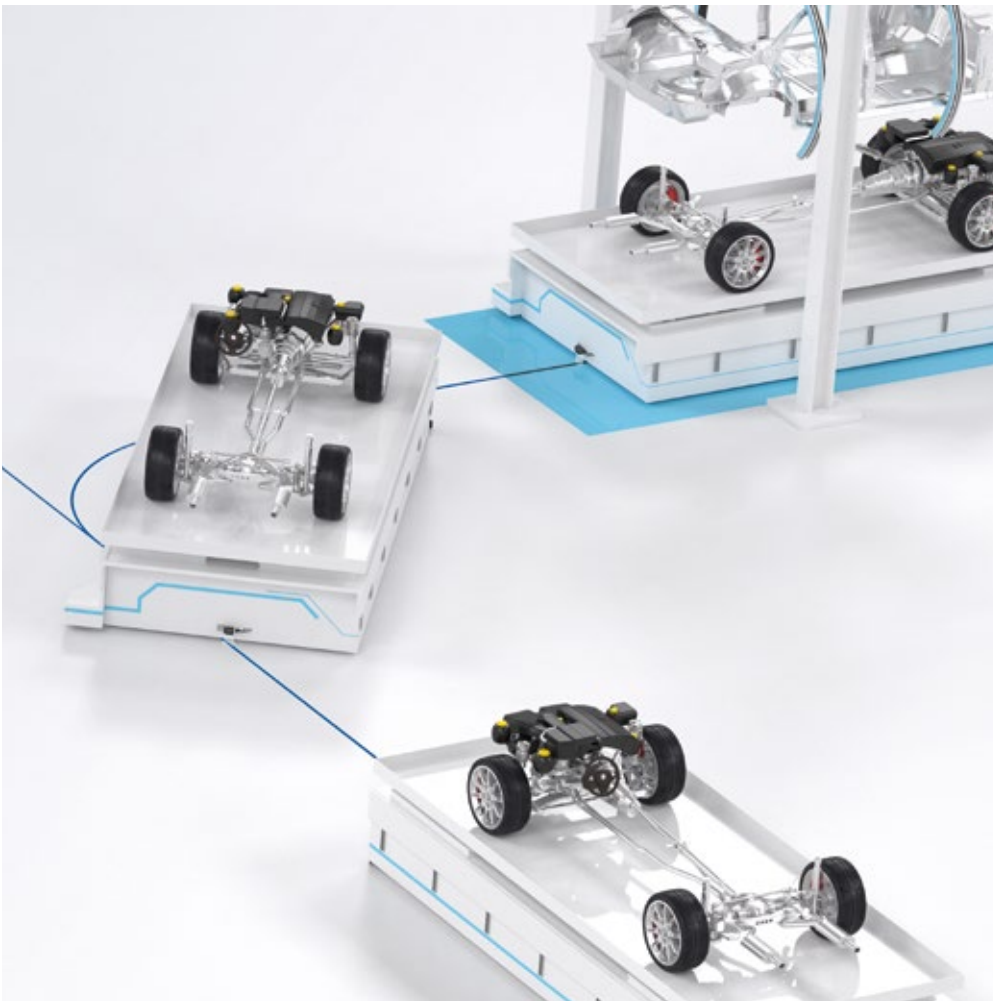

Inclination and Acceleration Sensors **Absolute Precision— in Any Environment**

Whether they are leveling cranes, controlling elevators, or monitoring front-loader tilt, inclination and acceleration sensors from Pepperl+Fuchs ensure precise measurements—even in harsh outdoor conditions.

Unique, Protective Mounting Concept

Based on a two-piece concept, F99 series sensors consist of the sensor module and a rugged metal mounting bracket. The bracket provides impact protection while allowing easy assembly with an integrated screw. This increases the sensor's resistance to vibration and shock and allows quick and easy replacement without the need for adjustment or calibration.

The Right Sensor for Any Requirement

Every application places different demands on sensors. With Pepperl+Fuchs' broad portfolio of inclination and acceleration sensors, you can select from a wide variety of features to find the best fit for your application requirements.

In addition to sensors for inclination and acceleration detection, F99-Fusion inertial measurement units are also available. The six-axis F99-Fusion compensates for external acceleration and can provide 360° of precise inclination and acceleration data.



For more information, visit
www.pepperl-fuchs.com/fa-f99





Inclination and Acceleration Sensors

Maximum Precision for Dynamic Applications

For the first time, the F99-Fusion inertial measurement unit makes error-free inclination detection possible in applications where there is multidirectional movement. The innovative combination of an acceleration sensor and gyroscope compensates for external acceleration to increase performance and open up new possibilities.



Inclination sensor



Acceleration sensor

Typical Applications

Inclination Sensors:

- Leveling work platforms
- Adjusting alignment in solar plants

Acceleration Sensors:

- Monitoring mechanical vibration limits in wind turbine installations
- Controlling acceleration in elevators

F99-Fusion Inertial Measurement Unit:

- Monitoring steering-angle limit on inclines for construction machinery
- Onboard weighing systems in port cranes

Key Benefits

- Compensation of multidirectional acceleration enables quick, precise, and dynamic inclination measurement (F99-Fusion)
- Variety of measurement outputs for complete application flexibility (F99-Fusion)
- Combination of accelerometer, gyroscope, and inclination technology in a single device allows six-axis, 360° measurement and mounting in any orientation
- IP68/69K rating and protective mounting bracket provide maximum durability for outdoor use
- E1 and GL approvals allow for a wide range of applications, including off-road and marine use

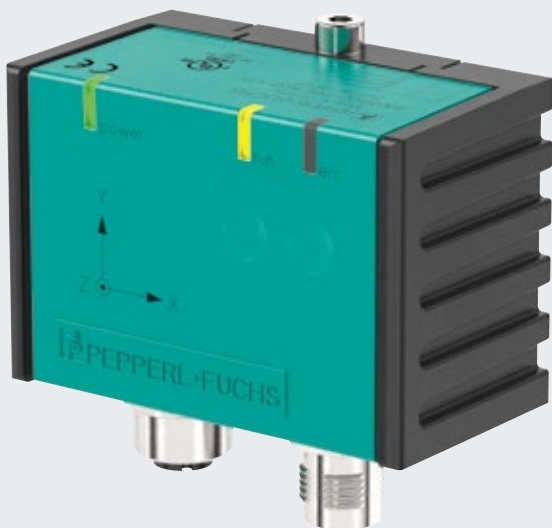

F99-Fusion inertial measurement unit

Technical Features

- Maximum environmental protection with IP68/69K rating
- Increased EMV immunity: tested according to ISO 7637 and ISO 11452
- Extended temperature range of -40 to $+85$ °C
- Increased resistance to mechanical shock and vibration up to 100 g

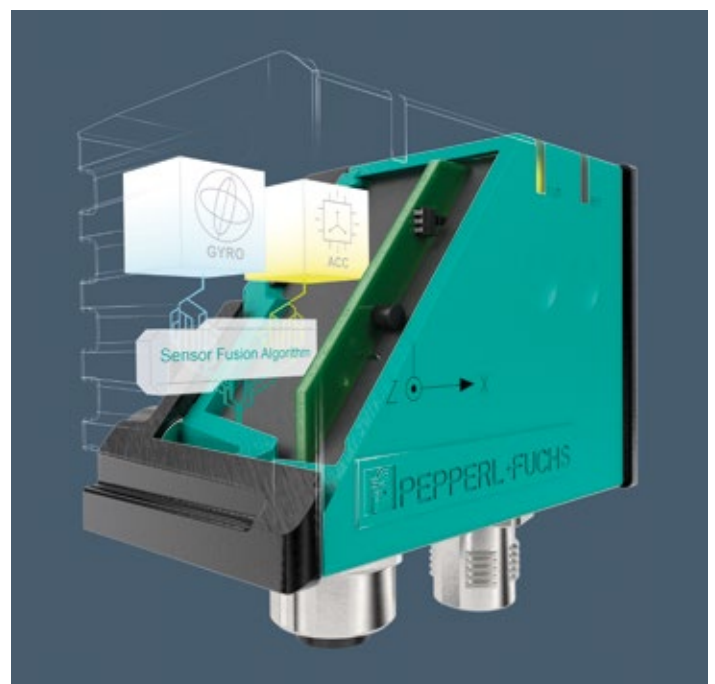

F99-Fusion internal measurement unit:
Intelligent combination of acceleration sensor and gyroscope for maximum precision in applications with dynamic motion.

Inclination and Acceleration Sensor Applications

Improving Existing Applications and Creating New Ones

Inclination sensors are used in a range of industries. With F99-Fusion technology, existing applications can be handled more efficiently, and completely new applications can become a reality.

Monitoring Steering-Angle Limit on Inclines

The ability to compensate for external acceleration opens up a host of new applications. One example is monitoring steering-angle limits on inclines. When heavy vehicles like wheel loaders or dump trucks take a turn too sharply on an incline, they can easily tip over. Forklifts have the same problem, especially when the forks are extended.

The F99-Fusion provides 360° monitoring of the vehicle's inclination. Using the data provided by the sensor, the steering angle can be limited to prevent tilting. With this unique technology, the measurement is not affected by changes in speed or direction—making it applicable to a wider range of mobile equipment applications.

Making Onboard Scales More Efficient

In onboard scales on heavy equipment such as trucks, trailers, and forklifts, weight is often calculated directly on the vehicle. In these systems, external acceleration can cause measurement errors, which can only be corrected after the fact—if at all—with complex calculations.

In modern wheel loaders, for example, the weight of the material being loaded is detected directly in the bucket. Existing solutions would require a delay in order to take exact measurements, and because any lost time is costly, measurement errors are often accepted.

Weight calculation in port cranes is similar. In order to ensure an even weight distribution while large freighters are loaded, the weight of each container is measured as it is being lifted. Delays are not an option in this environment, so conventional cranes often do not provide onboard weighing.

Because the F99-Fusion compensates for external acceleration, weight calculations can be made immediately during the loading or unloading process. With this feature, weight can also be calculated while a freighter is underway, dramatically increasing the efficiency of the overall process.

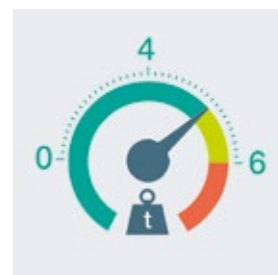

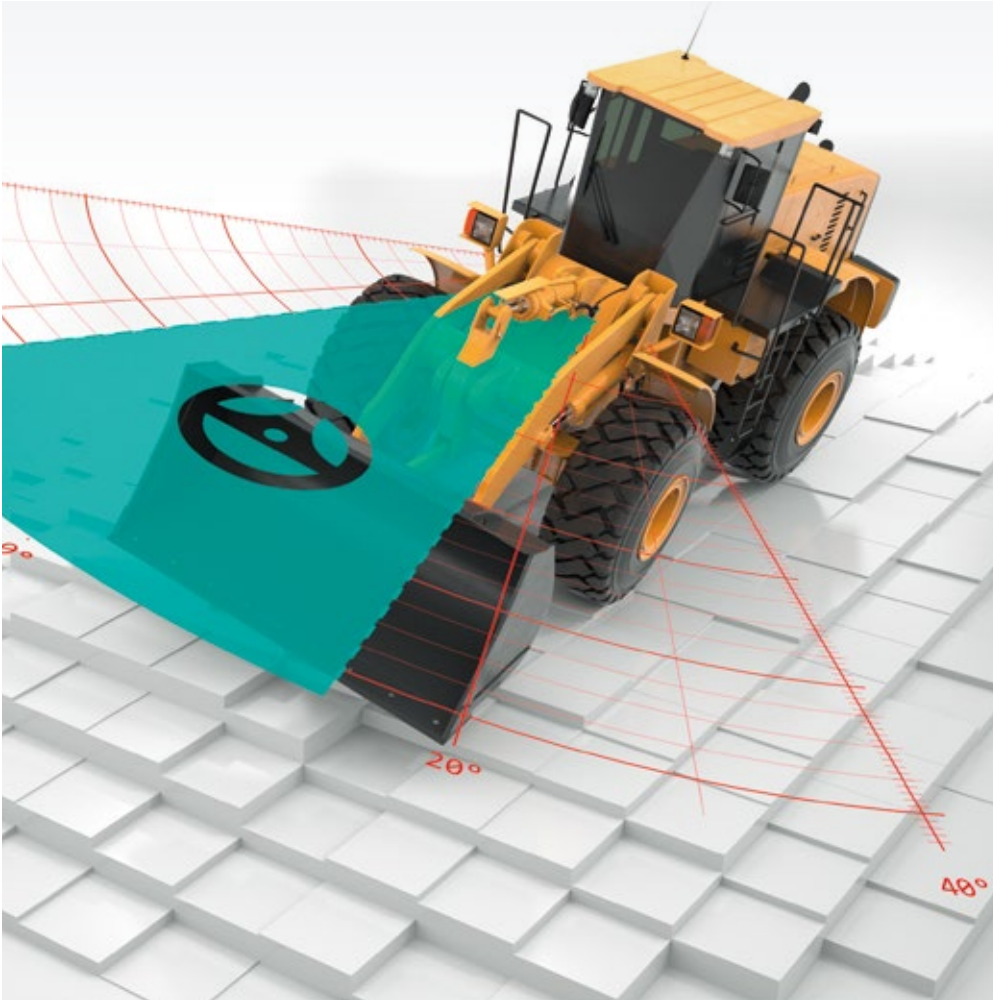

For more information, visit
www.pepperl-fuchs.com/fa-mobile



Rotary Encoders

Maximum Versatility for Standard and Special Applications

A wide product selection, deep technical expertise, and reliable sensor technology. Regardless of the application or market, our rotary encoder portfolio offers perfectly tailored solutions to meet the requirements of every application—even in extreme conditions.

Benefitting from All Technologies

Complex applications require technologies that are reliable in any circumstances, regardless of the environment. Leveraging a range of proven technologies, Pepperl+Fuchs can offer the optimal solution for any application. For both industry-standard and special applications as absolute or incremental rotary encoder, our broad portfolio provides countless configuration options and gives you complete flexibility to select the perfect rotary encoder.

Channeling Application Expertise into Custom Solutions

Custom solutions complement our extensive portfolio. Pepperl+Fuchs' team of experts is committed to providing competent, reliable advice, and close cooperation. Harnessing decades of technical experience, we work side by side with customers to develop solutions for even the most challenging applications. Over the years, we have created countless solutions for extreme conditions, including offshore, hazardous, and safety applications.



For more information, visit
www.pepperl-fuchs.com/fa-encoder





ENTL + FUCHS
Produktions-
0111YYRYGI-1213
8192
4096
IP rate: IP66
Vers.: 1
Part-Nr.: 236710
Ser.no: 06/15 816287



Industry-Standard Rotary Encoders

Precision for Reliable Automation

Powerful, reliable sensors are critical to maximizing machine uptime and efficiency. Pepperl+Fuchs' portfolio of industry-standard rotary encoders offers high-performance products with a variety of technologies, measuring methods, and mechanical and electrical interfaces.

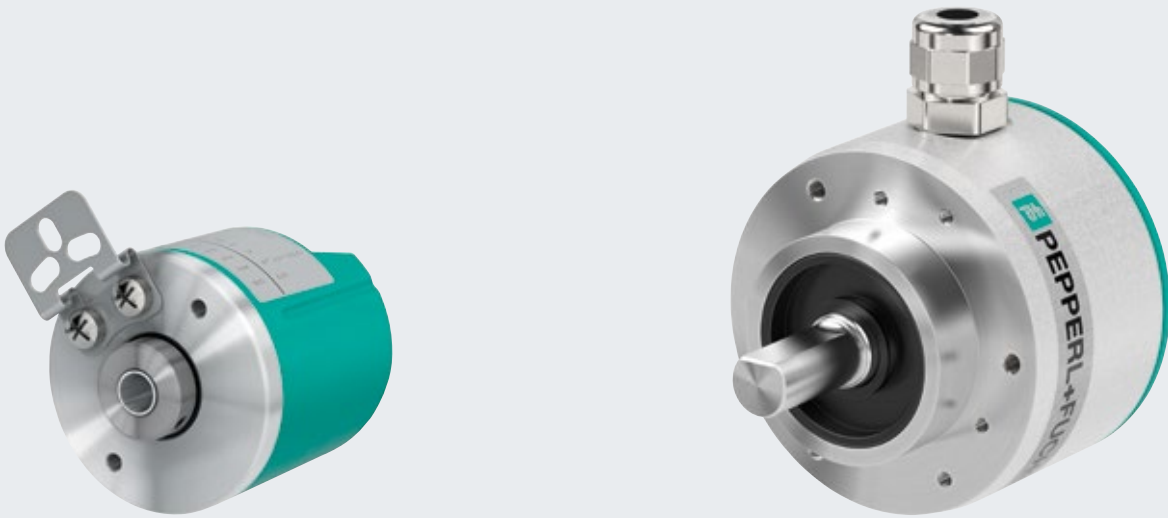

BlueBeam Technology for Unmatched Precision

Pepperl+Fuchs has integrated BlueBeam technology into incremental rotary encoders for the first time, setting new standards for precision and reliability.



For more information, visit
www.pepperl-fuchs.com/fa-bluebeam



Optical Rotary Encoders

With accuracies of up to 0.01°, optical rotary encoders are the perfect choice for dynamic applications that require maximum precision.

Typical Applications

- Elevators, shaft positioning, medical technology, and CNC machining centers
- Material handling and storage—monitoring lift height on forklifts

Key Benefits

- Broad portfolio—from cost-effective standard rotary encoders to high-end devices, a wide range of models is available
- Flexible system integration due to a variety of mechanical and electrical interfaces
- BlueBeam technology provides unmatched precision even at the highest rotational speeds



Magnetic Rotary Encoders

Magnetic technology raises the bar for industry-standard rotary encoders. It allows accuracies up to 0.1°, more compact designs, and wear-free technology for maximum durability.

Typical Applications

- Robotics: controlling the rotation of robot arms
- Print and paper industry: rotational speed monitoring of rollers and motors
- Machinery and plant engineering: bottle conveyer systems, machine tools

Key Benefits

- Magnetic rotary encoders with advanced Hall-effect technology for dynamic processes
- High resolution and absolute accuracy from <math><0.1^\circ</math> for precise applications
- Durable, wear-free technology for high reliability

Bearing-Free Rotary Encoders

Bearing-free rotary encoders combine a robust measuring system with intelligent assistance functions and are distinguished by their small size. Noncontact, wear-free detection allows continuous operation.

Typical Applications

- Rotation speed monitoring on machine tool motors
- Position feedback on a solar tower
- Rotation speed monitoring for drive motors in space-restricted installations

Key Benefits

- Resistant to dirt and thermal and mechanical shock
- Efficient solution with a long service life at high rotational speed and temperature
- Assistance functions and LED indicator for simplified installation and testing

Special Rotary Encoders

Maximum Performance in Extreme Conditions

Beyond the industry standard, there are many extreme areas that require heavy-duty solutions. For these applications, Pepperl+Fuchs offers an optimized portfolio of durable rotary encoders along with competent, practical expertise.

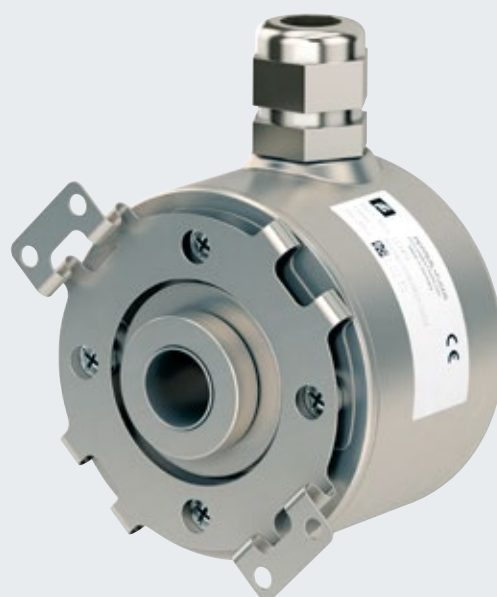

Safety Rotary Encoders

Certified safety rotary encoders play a key role in machine and system safety. They are backed up by innovative technologies, use existing communication channels, and comply with safety categories up to SIL 3/PL e.

Typical Applications

- Plants in a variety of industries that fall under the requirements of Machinery Directive 2006/42/EC
- Positioning of rotating elements on heavy machinery
- Positioning of electric monorail hangers

Key Benefits

- Ensuring protection of personnel, equipment, and the environment
- Reducing safety-related downtime
- Continuous plant operation during maintenance or retrofitting

Offshore Rotary Encoders

Specially developed for use in marine environments and cold climates, these rotary encoders can withstand shock, mechanical vibration, high levels of humidity, and temperatures down to -40°C .

Typical Applications

- Offshore and naval engineering: wind turbines, gantry systems, or spreaders
- Renewable energy: rotation monitoring of the nacelle and rotor blades on wind turbines, rotation speed monitoring of generators
- Mobile equipment: port cranes and loaders

Key Benefits

- Resistant to high humidity and corrosion due to special housing coating
- Absolute immunity to electromagnetic interference
- Long service life through sturdy sensor design with special shaft construction and IP69K protection

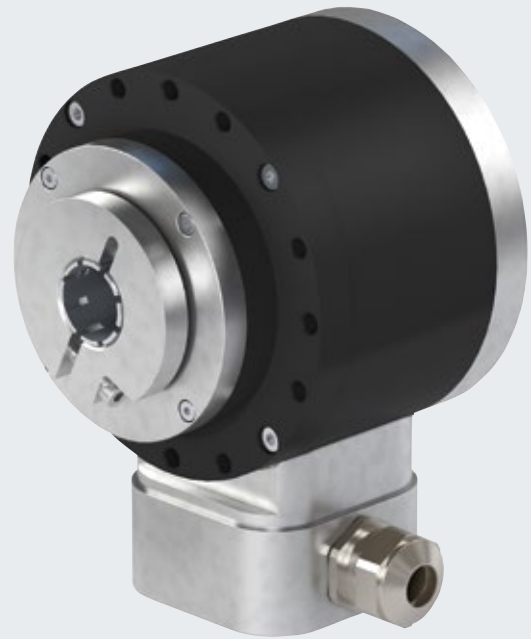
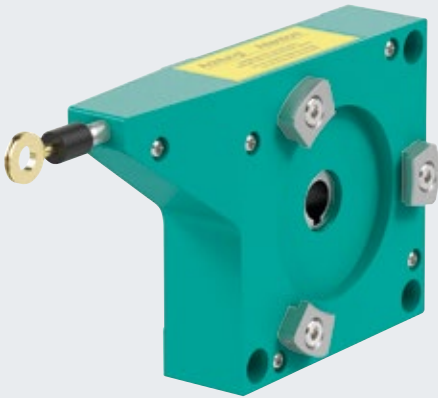

Cable Pulls

Pepperl+Fuchs' portfolio of cable pull rotary encoders is designed using a modular product architecture, allowing a perfect match of all components. They can be used in almost any application and range from compact models to rugged, heavy-duty versions for harsh environments.

Typical Applications

- Linear distance measurement in scissor lifts, cranes, and storage and retrieval systems

Key Benefits

- Wide range of models with measuring lengths up to 60 m— from compact designs to rugged, heavy-duty versions
- Various housing materials from plastic to anodized aluminum for extreme conditions
- Comprehensive selection of accessories, including cable attachments and guide pulleys allow flexible use in any application

Heavy-Duty Rotary Encoders

Designed for the toughest outdoor applications, these models resist heat, cold, dirt, extreme mechanical vibration, shock, and electromagnetic interference. Heavy-duty rotary encoders are built to withstand increased force and high shaft loads.

Typical Applications

- Steel mills and lumber mills
- Outdoor lifting machinery
- Mobile equipment: construction machinery, including cranes, excavators, rollers, and loaders

Key Benefits

- Robust and shock-resistant rotary encoders with high immunity to electromagnetic interference
- Can be used in the most adverse conditions due to IP69K protection and protective housing materials
- Increased service life due to wear-free technology and increased shaft loads up to 400 N (axial) and 300 N (radial)

Rotary Encoder Applications

Protected Processes in Hazardous Locations

Whether it is oil and gas production, chemical processes, or other industrial plants with flammable gas mixtures or dusts—as a global leader in the field of explosion protection, Pepperl+Fuchs stands for the highest standards and safe processes.

For Every Hazardous-Area Application, a Reliable Solution

The variety of applications in hazardous areas is almost unlimited. Different requirements apply in terms of what type of protection to consider for industry- or country-specific directives. To meet these requirements, Pepperl+Fuchs provides appropriate types of protection, including flameproof (Ex d) and intrinsic safety (Ex i). Various rotary encoder options are available for use in Zones 1, 2, 21, and 22. Certificates such as IECEx, Ex NEPSI, or KOSHA round out the selection.

Pipe Handler Positioning under Extreme Conditions (1)

Oil extraction takes place at depths of up to several thousand meters. In order to drill this deep, various drill rods are required. A pipe handler supplies the rods from a storage location to the drill spindle. Positioning of the entire unit and the gripper is performed with a rotary encoder, among other devices.

In addition to strict requirements for the hazardous-location approval of the device, the rotary encoder must also be able to withstand extreme weather conditions, massive vibration, and corrosive atmospheres. Pepperl+Fuchs offers a perfectly coordinated portfolio for almost any application in hazardous locations.

Explosion Protection from Pepperl+Fuchs

Protecting your plant is our core competence. With technologies and solutions for process automation, we work side by side with you as a reliable partner. Our decades of experience, in-depth application expertise, and ongoing dialogue with our customers form the basis of a comprehensive portfolio for every requirement level.

For more information, visit
www.pepperl-fuchs.com/fa-ex



Cable Pull Rotary Encoders for Linear Position Measurement on Grippers (2)

A cable pull rotary encoder is used for vertical positioning of the gripper on a pipe handler. It detects the lifting height of the hydraulic cylinder and measures the distance traveled via the measuring cable. This allows an optimal supply of the rods needed for drilling. In addition to hazardous-area rotary encoders, Pepperl+Fuchs offers a variety of cable pull rotary encoder combinations, including saltwater-resistant models and cable pulls with guide pulleys.



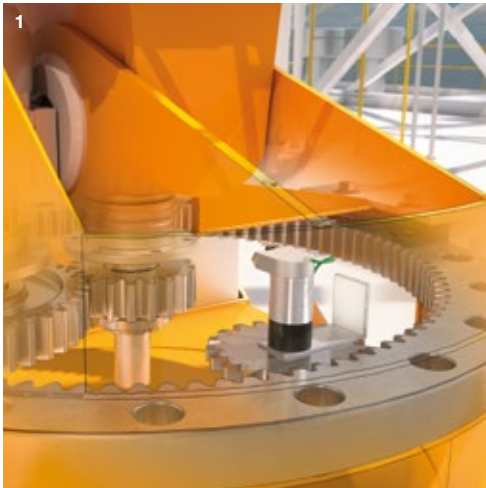

For more information, visit
www.pepperl-fuchs.com/fa-process



Industrial Communication

Versatile and Future-Proof System Solutions

Access to data in the Internet of Things is a central component of Industry 4.0. To make the communication of industrial networks more efficient and flexible, Pepperl+Fuchs offers powerful components that reliably transport large quantities of data across all levels. Users benefit from maximum efficiency and increased system transparency.

SmartBridge®

SmartBridge® technology enables convenient access to any IO-Link device. It allows interruption-free access to process data and valuable status information for connected devices. It transfers this data—independent of the machine control—to a smartphone or tablet.

Fieldbus Modules

For connecting sensors and actuators in the field, Pepperl+Fuchs offers innovative Ethernet IO modules. They open up a new dimension of universal connectivity for future-proof automation. Their decentralized control function allows self-sufficient control of applications and efficient, needs-based machine communication via the selective transmission of data. Modules with integrated IO-Link master provide full process transparency, right down to the sensor/actuator level.

AS-Interface

For efficient wiring of machines and plants, Pepperl+Fuchs offers a complete solution based on a variety of AS-Interface components and compatible sensor technology. Wiring via topology-free, two-wire flat cable allows maximum flexibility and easy integration into existing systems. The well-established and manufacturer-independent system provides absolute investment security.



For more information, visit
www.pepperl-fuchs.com/fa-communication





SmartBridge®

Easy Access to IO-Link Devices

Condition-based maintenance, process optimization, and service on demand—these have become a reality with SmartBridge® technology. SmartBridge® takes valuable status data from automation components and makes it directly available to higher-level information systems.



Using Field Devices as a Valuable Source of Data for Process Optimization

Cyclic process data from field devices builds the basis for how machine control systems regulate processes. Simultaneously, intelligent field devices deliver a wealth of valuable, acyclic status information.

SmartBridge® technology captures status information and process data and transmits it wirelessly. This allows information about the operation status of the individual components to be transmitted directly to mobile devices, higher-level information systems, and service systems—bypassing the machine control system.

Typical Applications

- Setup, control, and maintenance of IO-Link devices
- Configuration of IO-Link systems that are integrated into machine modules, such as dosing pumps or robot grippers
- Monitoring statuses of IO-Link devices, such as runtime, switching cycles, or contamination
- Analysis of machine functions and manufacturing processes

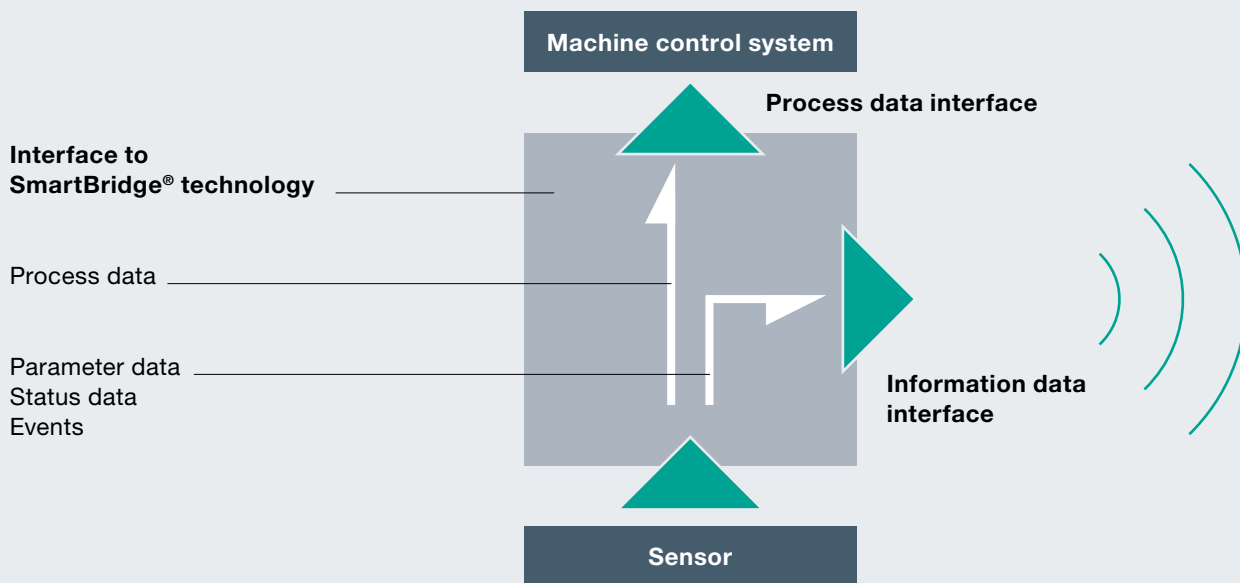

Principle of SmartBridge® technology

Key Benefits

- Simple configuration of IO-Link devices via graphical interface
- Access to cyclic and acyclic status and event data for monitoring IO-Link devices with a mobile device
- SmartBridge® app provides a consistent and easily understandable user interface for IO-Link compatible field devices, regardless of device manufacturer
- Easy integration into existing infrastructures via plug-and-play for data access without interrupting the manufacturing process
- International standards such as Bluetooth and IO-Link for investment security

Technical Features

- Built-in SD card slot for data logging
- Intuitive operation via smartphone or tablet with the SmartBridge® app
- Automatic control and display files for all IO-Link devices

Fieldbus Modules

Reliable Communication across All Levels

A rugged module for all standard Ethernet protocols, IO-Link, and integrated, decentralized control and diagnostics function. Fieldbus modules from Pepperl+Fuchs are a perfect fit for the requirements profile of innovative machine and plant builders—and Industry 4.0.

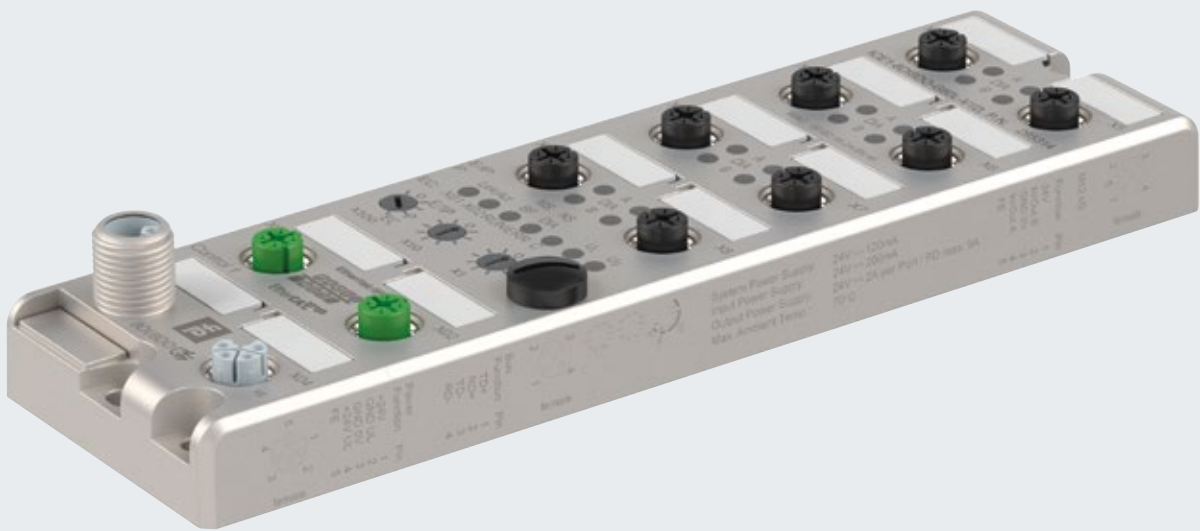

Ethernet IO Module with integrated control function

Typical Applications

Fieldbus modules act as interfaces for industrial fieldbus systems. They enable efficient communication between control systems and the field level. Typical applications for these modules include:

- Automotive industry: networking in final assembly
- Production lines: switch control for sorting scrap via decentralized logic
- Packaging machines: monitoring wear for preventive maintenance

Key Benefits

- All standard Ethernet communication protocols are supported in a single module for optimal machine standardization
- Innovative M12 power connector for reduced installation costs thanks to higher current rating of 2x 16 A for sensors and actuators
- Integrated IO-Link master for continuous diagnostics and parameterization from the control system to the sensor level
- Integrated, decentralized control function allows self-sufficient functionality independent of the PLC
- Comprehensive diagnostics available through Web server for more transparency and increased process reliability

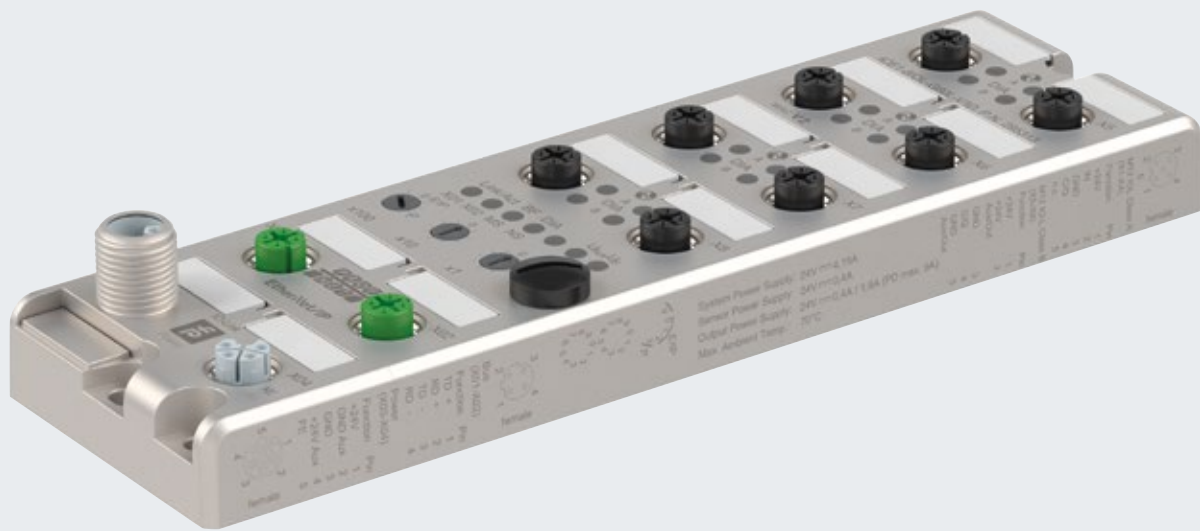

Ethernet IO Module with integrated IO-Link master

Technical Features

- Fully encapsulated metal housing with IP67 protection: ideal for mounting directly on the machine with high resistance to shock and mechanical vibration
- Connection of sensors and actuators via 16 digital inputs, 8 digital inputs/outputs, or 8 IO-Link sensors/actuators
- Future-proof with IO-Link Standard V1.1 in accordance with IEC 61131-9
- Rotary switch for setting the communication protocol (PROFINET, EtherNet/IP, EtherCAT) provides easy operation
- Highly visible, channel-accurate status LEDs as well as displays for communication, diagnostics, and power supply for status control

AS-Interface

Simple and Efficient System Wiring

Firmly established as a global standard, AS-Interface enables fast and efficient connection of automation components. Its simplified control system, topology-free optimized installation, and improved diagnostics capabilities provide a clear increase in productivity.



AS-Interface Flat Cable

The flat cable for AS-Interface and AUX is ideal for quick and easy wiring. With piercing technology, all components of the automation technology can be connected efficiently.



Key Benefits

- Complete solutions consisting of AS-Interface components and compatible sensors from Pepperl+Fuchs
- Simple mounting and operation: a flat cable for power and data transfer
- Maximum flexibility with topology-free, optimized installation
- Reliable, error-free mounting with piercing technology
- Flexible integration of safety components up to SIL 3/PL e without network changes
- Established, manufacturer-independent system for investment security
- Cost-effective connection to all I/O signals



Typical Applications

- Efficient wiring of complex conveyor systems and integration of sensors and actuators into existing systems
- Consistent wiring of extensive plants in the process industry
- Flexible use of safety components in the automotive industry

Technical Features

- Interoperable system, compatible with nearly all control systems
- Additions are possible anywhere on the flat cable
- Replacement of modules with automatic addressing
- Comprehensive diagnostics
- Transfer of safe and unsafe signals over one line
- Standardized wiring in machine building with integrated safety function
- Cost-effective, compact wiring in the packaging industry

Masters and Gateways

Pepperl+Fuchs offers gateways for all common fieldbus systems: PROFINET, EtherNet/IP, EtherCAT, PROFIBUS, DeviceNet, CC-Link, etc. This allows simple and standardized data transfer to the higher-level control system. In addition, gateways with integrated safety monitors are available for reliable monitoring of both AS-Interface segments.

Power Supplies

Every AS-Interface segment requires a power supply. These include data decoupling for interference-free communication on the AS-Interface secondary circuit. Alternatively, double masters with integrated data decoupling are available that can be operated with a power supply.

AS-Interface Modules

Versatility for Field Applications and Cabinet Installation

Durability and compactness for field applications. Fast wiring and simple diagnostics in the control cabinet. Pepperl+Fuchs offers a variety of specific modules for efficient transfer of digital, analog, and safe signals.



Modules for Field Applications

For field applications, Pepperl+Fuchs offers a variety of perfectly coordinated AS-Interface modules. They offer exactly what is required: compact design, high environmental protection, and quick, easy installation. Their robust design and high degree of protection ensure durability.

Key Benefits of Selected Modules

G10—the Ultra-Compact Module:

- Flexible mounting directly in the cable duct
- Quick installation with a one-piece housing concept and captive central screw
- ECOLAB certified and IP68/69K protection
- Many models available—including a G10 safety module

G11, G12, and G16 Modules—a Range of Housing Designs:

- Sensor connection via M12 or M8 connectors
- Simple mounting in various housing designs
- Tool-free installation (G12)
- Connection of analog devices (G11)

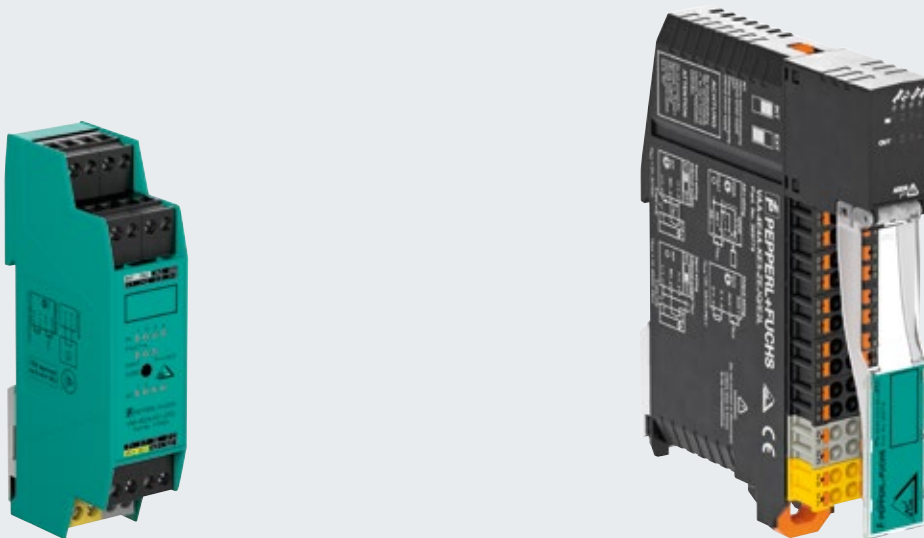

Modules for Cabinet Installation

Switch cabinet modules have different requirements than modules for field applications—features such as space- and time-saving installation and simple diagnostics are crucial. The KE5 module in particular, with a front-panel, push-in connection, perfects switch-cabinet wiring.

Key Benefits of Selected Modules

KE5 Module—Unique Switch Cabinet Wiring:

- Front-panel, push-in connection simplifies installation
- Extremely narrow housing, <19 mm, with 28 terminals and downward cable routing for optimized cabinet space
- Multicolor backlit I/O display and labeled front cover provide unmistakable I/O association
- Channel-specific overload indication

Technical Features

- Dimensions (W x D x H): 19 x 99 x 125 mm
- Total current 6 A without derating
- Up to 2 A output current per channel
- Selectable supply to the sensors: external or from AS-Interface
- Bridged connections for AS-Interface and AUX terminals
- Connection up to 2.5 mm²

Industrial Communication Applications

Ethernet IO Modules for Maximum Transparency across All Levels

One module for all Ethernet-based protocols, comprehensive diagnostics, and IO-Link: Ethernet IO modules from Pepperl+Fuchs are versatile and reliable. They enable efficient communication between the control system and the field level.

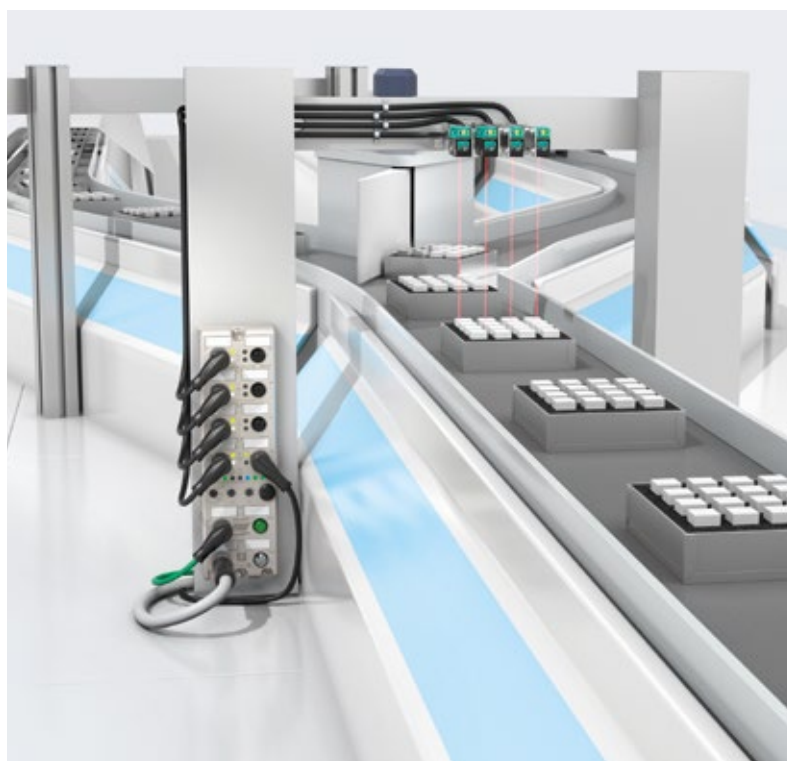
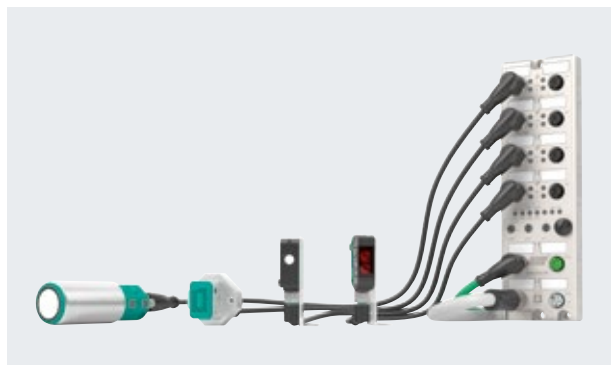

Uniform Communication Standard and Maximum Transparency with IO-Link

Used in modern production lines, intelligent Ethernet IO modules from Pepperl+Fuchs enable standardization with multi-protocol communication. An innovative solution that allows all Ethernet-based control systems to be used with a single module.

With an optional integrated eight-way IO-Link master, these modules enable direct connection of up to eight IO-Link devices. This allows parameters to be set, measurement and switching signals to be transferred, and diagnostics to be carried out. The result is more transparency down to the sensor or actuator level and improved process performance.

Prefailure warning, predictive maintenance, simple restart after sensor replacement, and an overview of the entire system are all possible—completely in line with Industry 4.0.

Key Benefits of the Ethernet IO Module with IO-Link Master

- Enables continuous diagnostics and parameterization right down to the sensor/actuator level
- Simplifies device replacement and commissioning: automatic transfer of preconfigured parameters when several sensors are connected
- Supports eight IO-Link channels for sensors (Type A) and actuators (Type B)
- Future-proof with IO-Link standard IEC 61131-9

AS-Interface Module for Decentralized Motor Roller Control

For connecting automation components quickly and efficiently, AS-Interface and the G20 motor roller module are the perfect solution. The G20 module allows decentralized, on-demand control of DC motor rollers and, with an innovative design, enables preassembly of conveyor segments.



Intelligent Conveyor Technology through Decentralized Control

Modern roller conveyor systems consist of segments that can be controlled individually based on the position of the product. The presence of goods is detected by a sensor, and the signal is transferred to the nearest motor roller.

The G20 AS-Interface module is used to control the motor rollers. Up to eight speeds and various acceleration profiles can be configured and adjusted. This allows high-precision start and stop positions that adapt to the products being transported.

The innovative design of the module offers a key advantage: all automation components can be connected directly to the module and preassembled in the factory. Segments can be produced, and the flat cable can be installed on-site.

Key Benefits of the G20 Motor Roller Module

- DC motor roller module version available for controlling speed, direction, and start/stop function on material handling conveyors
- Digital version available for simple ON/OFF solutions for motors or pneumatic actuators
- Simple, tool-free installation: one-piece housing with a flat cable connection and direct connection to the sensor/actuator
- Preassembly and delivery of segments, with AS-Interface flat cable installed on-site

Connectivity

Connection Technology for Automation

High-performance sensors need strong connections to match. Driven by the goal of making your applications as simple, efficient, and reliable as possible, we have developed an integrated product portfolio that provides everything you need for optimal sensor connectivity.

Perfectly Matched Products from a Single Source

As innovators and pioneers in sensing technology, we channeled decades of practical experience into a connectivity portfolio that is perfectly adapted to your automation needs. By providing sensors and their corresponding connection components from a single source, we boost your productivity and increase the performance of machines and plants.

Excellent Quality in Any Environment

Pepperl+Fuchs products are used in a wide range of applications, including those that take place in harsh and hazardous conditions. This is why we set the highest quality standards for our entire product portfolio, including our connectivity products. With zero-defect tolerance, automated functional testing of every item, and state-of-the-art production at our facility in Hungary, we deliver reliable products that will stand the test of time.



For more information, visit
www.pepperl-fuchs.com/fa-connectivity





Sensor-Actuator Cables

Standardized and Perfected for Maximum Durability

Built on years of application experience, sensor-actuator cables from Pepperl+Fuchs ensure maximum durability, application reliability, and service life. They are developed based on real-world market needs and carefully designed with every detail in mind.

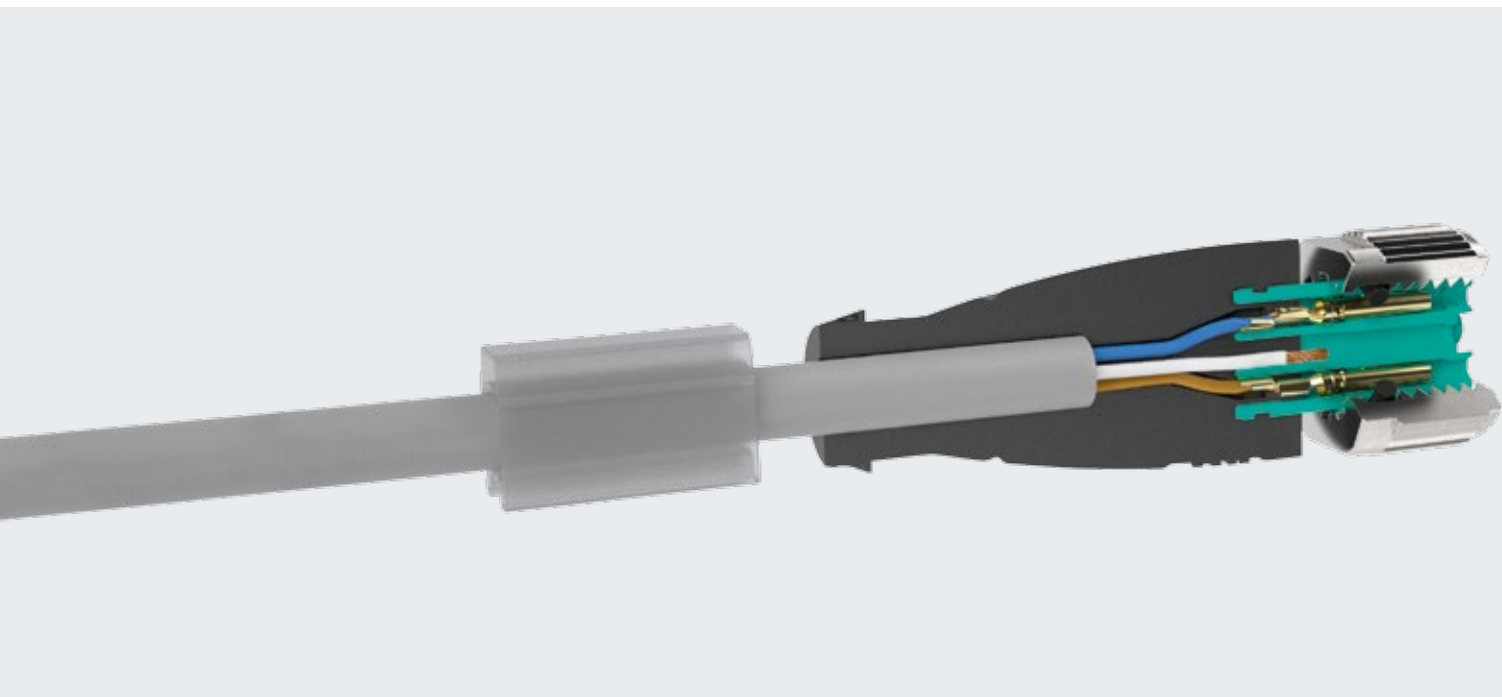

Key Benefits

- Connectors with knurling and hex flat for quick and easy fastening by hand or tool
- FKM captive seal for high-quality connections and maximum chemical resistance
- Integrated fixed stop for torques from 0.4 Nm to 1.0 Nm to protect the O-ring
- Highly durable with optimized vibration protection and gas-tight connections
- Doubled creepage distance and IP68/IP69K protection for harsh industrial applications

Wide Selection of Cable Types

No two applications are exactly alike, and each installation environment has its own unique requirements. Since the features and advantages of the connection technology are crucial in determining the best solution, Pepperl+Fuchs offers the right cable for every situation.

- PVC—solid and economical
- PUR—durable and highly flexible
- PUR-U—highly flexible with UL approval
- PUR-A—resistant to welding sparks for the automotive industry
- PUR-O—for tough outdoor applications
- PUR-R—highly flexible for demanding robotics applications
- STOOW—designed specifically for the American market
- POC—designed specifically for welding areas

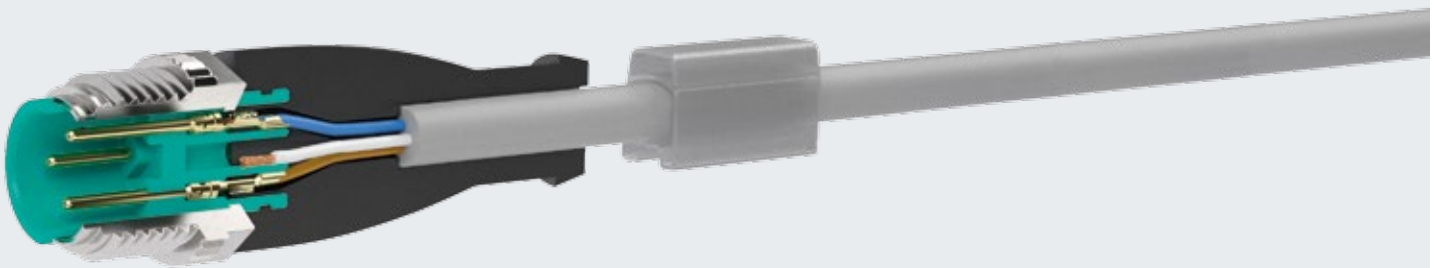

Technical Features

Mounting without a Datasheet

- Pinouts are printed on the socket
- Easy-to-see arrow on the grip aligns with the connector key

Quick and Easy Installation

- Quick fastening by hand via knurling or open-end wrench via hex flats
- Protection of O-ring and wide torque ranges with integrated fixed stop
- Easy status diagnostics, even in bright light, with high-contrast LED models

100° Angle for Longer Service Life

- Reduced strain on wires increases service life
- Innovative catch design makes securing protective cable loom quick and easy

High-Performance, Even in Harsh Environments

- Optimized vibration protection with radially mounted latches
- Increased tolerance against contamination from moisture, dirt, and dust with doubled creepage distance

Connectivity Product Portfolio

More Than Just Connectors and Cordsets

In addition to connectors and cables, Pepperl+Fuchs offers a range of components that ensure long-term functional reliability and machine operation. Among these are fully encapsulated Y-splitters that provide the ultimate in flexibility and field-attachable connectors that are a convenient solution for customizing connectivity to your application.



Sensor-Actuator Splitters

Splitters allow you to easily merge two signals into one junction block port. They are also suitable for cost-effective looping of bus signals to minimize wiring.

- Fully encapsulated housing with IP68 protection
- Available with sockets or molded cables
- Variety of cable lengths available

Field Connectors

A wide range of field-attachable connectors suitable for a variety of applications. Ideal for maintenance, easy repair, or plant expansion on-site.

- Plastic and metal versions
- Shielded and unshielded versions
- Different connector sizes, including M8, M12, 7/8", and others, with screw connection or insulation displacement technology
- Allows for cable configuration on-site

Junction Blocks

M8 and M12 multipoint sensor connection blocks with master cable or connector for easier installation.

- Fully encapsulated housing with IP68 protection
- 100 % tested for complete reliability
- Integrated LEDs for easier diagnostics
- Wide socket separation (M12) or offset sockets (M8) for easy-fit connection
- Rugged outdoor version also available

Sensor-Actuator Receptacles

Signal routing from the control cabinet directly into the field.

- Sealing in accordance with IP67/68
- Multiple connection types and pin counts
- Available with PG or metric mounting thread
- Cabinet wall mount, front or back



Data Connectors

Fieldbus cables enable you to establish a reliable network between the different components of your automation system.

- PROFIBUS
- PROFINET/Ethernet
- CAN/DeviceNet

Valve Connectors

As a solution provider, Pepperl+Fuchs provides ready-made components with robust designs.

- Fully overmolded housings with IP68 rating
- Overmolded, captive seal
- Various internal circuit types to provide built-in noise suppression
- Models in accordance with DIN industry standards
- Rugged outdoor versions available with stainless-steel screw and silicone seal

Installation Tools for Connectors

Speed and precision are crucial for both installation and maintenance. These installation tools allow our knurled coupling connectors to be attached securely at exactly the right torque.

Industry-Specific Connectivity Solutions

Every industry places individual requirements on connection technology. In addition to universal standard products, Pepperl+Fuchs also offers solutions that are tailored to individual requirements. One example is the Mobile Equipment Connectivity (MEC) series, which includes DEUTSCH connectors and other components that are designed for use on mobile equipment in extreme outdoor conditions.

Staying in Touch. The World Over.

Good customer relationships need care and attention. They are an indication of genuine interest, trust, and a cooperative spirit: the foundation of Pepperl+Fuchs' strengths. No matter where you might be, we are always nearby. And we speak your language—in more than 140 countries across the globe.



At Home on All Continents

Our customers are at the center of all our activities. Our world-wide network ensures that we provide them with the best possible service and support. Our world headquarters in Mannheim services Europe through a network of more than 40 affiliates. Asia is handled by our office in Singapore, with more than 1,000 employees in manufacturing, service, and sales. And our North American headquarters in Twinsburg, Ohio, is responsible for a comprehensive network of offices and sales partners in the USA, Canada, and Mexico.

No matter where in the world you may be, Pepperl+Fuchs is right nearby—and always there for you.



■ Mannheim

■ Singapore

Your automation, our passion.

Explosion Protection

- Intrinsically Safe Barriers
- Signal Conditioners
- Fieldbus Infrastructure
- Remote I/O Systems
- HART Interface Solutions
- Surge Protection
- Wireless Solutions
- Level Measurement
- Purge and Pressurization Systems
- Industrial Monitors and HMI Solutions
- Electrical Explosion Protection Equipment
- Solutions for Explosion Protection

Industrial Sensors

- Proximity Sensors
- Photoelectric Sensors
- Industrial Vision
- Ultrasonic Sensors
- Rotary Encoders
- Positioning Systems
- Inclination and Acceleration Sensors
- Fieldbus Modules
- AS-Interface
- Identification Systems
- Displays and Signal Processing
- Connectivity